

## EXPLORENT INSTRUMENTS

Tuning Forks, Noise Apparatus .....	5003
Anastigmatic Aural Magnifier.....	5005
Ear Specula.....	5007
Flexible Tension Arm.....	5011
Cotton Applicators, Ear Snare.....	5013
Ear Probes, Loops, Curettes and Spatula.....	5015
Ear Hooks.....	5017
Myringotomy Knives, Tympanum Perforators .....	5019
Suction Tubes .....	5021
Elevators, Raspatories, Sharp Curettes .....	5025
Benedict Instruments for Anthelix Scoring .....	5029
Ear Chisels, Gouges, Mallets.....	5031
Bone Rongeurs .....	5033
Atraumatic, Dressing and Tissue Forceps .....	5035
Scissors .....	5039
Needle Holder .....	5043

Retractors .....	5045
Micro Ear Knives .....	5049
Needles, Picks, Perforators .....	5051
Micro Hooks.....	5053
Micro Dissection Instruments.....	5057
Heermann Instruments .....	5059
Micro Gauge, Micro Measuring Device .....	5061
Accessories for Otologic Surgery.....	5063
Wire Crimpers .....	5065
Micro Ear Scissors.....	5067
Ear Forceps.....	5069
Micro Ear Forceps.....	5071
Ventilation Tube Inserters .....	5075
Burrs.....	5077

**RICHARDS INSTRUMENT SETS**

Antoli-Candela Set..... 5085

Austin Set..... 5087

Farrior Set, Goldman Set ..... 5089

Guilford Set ..... 5091

Hough Set ..... 5093

House Set..... 5095

Jordan Set, McGee Set ..... 5097

Ronis Set, Scheer Set..... 5099

Schuknecht Set, Shea Set..... 5101

Shea/Robertson Set  
Posterior Fossa Set..... 5103

**MANUFACTURER (EXPLORENT)**

evonos GmbH & Co.KG  
Stockacher Str. 134  
78532 Tuttlingen, Germany

**DISTRIBUTOR (EXPLORENT)**

Olympus Surgical Technologies Europe  
Olympus Winter & Ibe GmbH  
Kuehnstr. 61  
22045 Hamburg, Germany



- Tuning forks with or without foot
- Noise apparatus with olive tip

**EXPLORENT**

## Hartmann Tuning Forks

**Turning fork, acc. to Hartmann**  
nickel-plated steel

- WT138000 Tuning fork, acc. to Hartmann,  
concert pitch C = 128
- WT138001 Tuning fork, acc. to Hartmann,  
concert pitch C1 = 256
- WT138002 Tuning fork, acc. to Hartmann,  
concert pitch C2 = 512
- WT138003 Tuning fork, acc. to Hartmann,  
concert pitch C3 = 1024
- WT138004 Tuning fork, acc. to Hartmann,  
concert pitch C4 = 2048
- WT138005 Tuning fork, acc. to Hartmann,  
concert pitch C5 = 4096

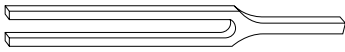

**Tuning fork**  
nickel-plated steel, with foot

- WT138301 Tuning fork, with foot,  
concert pitch A1 = 440

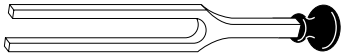

**Tuning fork, set**  
in case

Delivery includes: tuning forks WT138201, WT138202,  
WT138002, WT138003, WT138004

- WT138500 Tuning fork, set

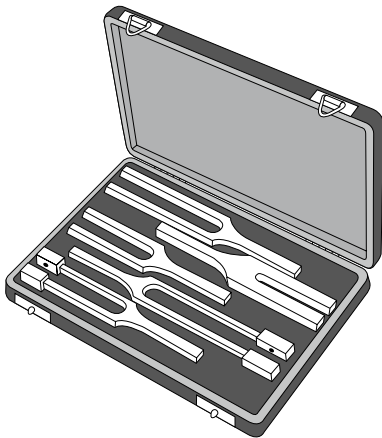

## Barany Noise Apparatus

**Noise apparatus, acc. to Barany**  
with olive tip

- WT139000 Noise apparatus, acc. to Barany, with olive

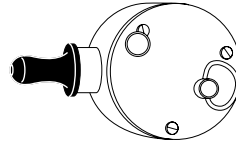

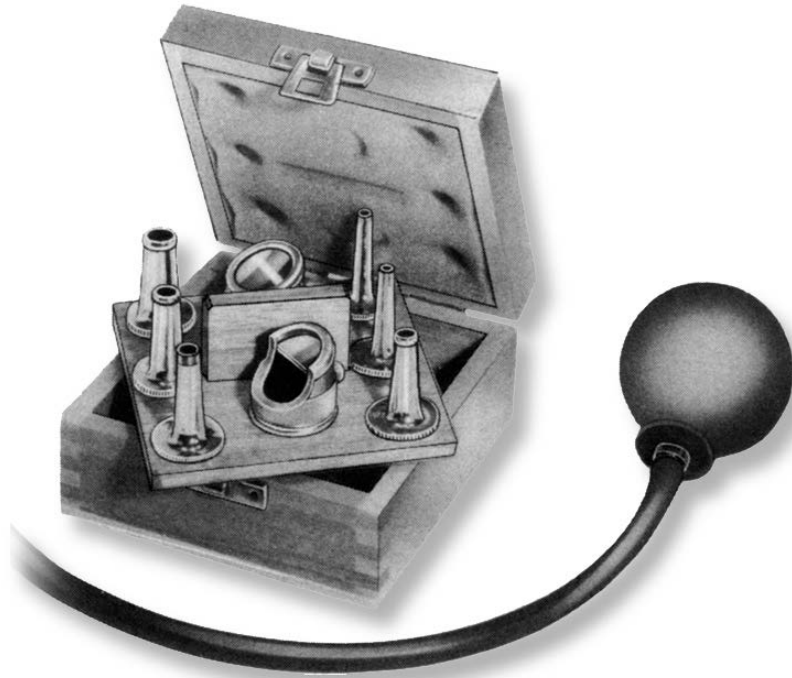

- Different sets
- Models with open and closed head
- Heads with or without magnification
- Additional specula available

**EXPLORENT**

## Bruenings Anastigmatic Aural Magnifier

### Anastigmatic aural magnifier, acc. to Brünings

complete in wooden case

Delivery includes:

ear speculum size 00 (WT119620), size 0 (WT119610), size 1 (WT119601), size 2 (WT119602), size 3 (WT119603), and size 4 (WT119604), magnifier head (WT119800), operating head, non-magnification (119900), rubber bulb (WT119300)

WT120600 Anastigmatic aural magnifier, acc. to Brünings, Set S

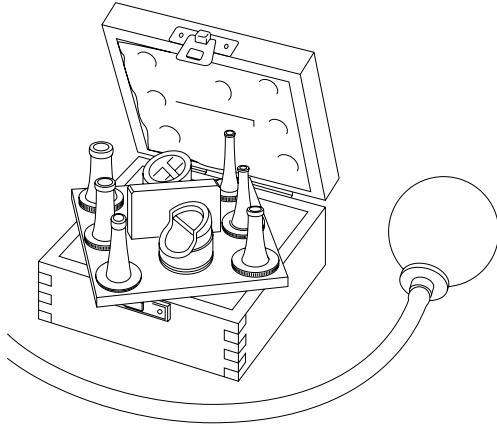

WT119300 Rubber bulb, acc. to Brünings, with tip, for aural magnifier

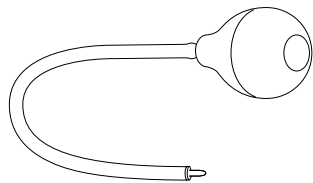

WT119700 Diagnostic head, acc. to Brünings, closed, without magnification

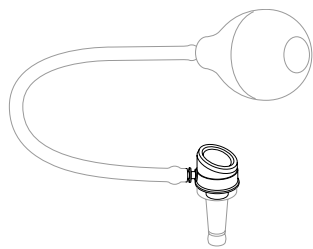

WT119800 Diagnostic head, acc. to Brünings, closed, with magnification

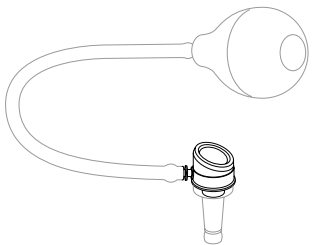

## Bruenings Ear Specula

### Ear speculum, acc. to Bruenings

inner and outer diameters (mm)

WT119620 Ear speculum, acc. to Brünings, size 2.5 x 4.0

WT119610 Ear speculum, acc. to Brünings, size 3.0 x 4.8

WT119601 Ear speculum, acc. to Brünings, size 4.0 x 6.0

WT119602 Ear speculum, acc. to Brünings, size 5.0 x 7.0

WT119603 Ear speculum, acc. to Brünings, size 6.5 x 8.5

WT119604 Ear speculum, acc. to Brünings, size 8.5 x 10.5

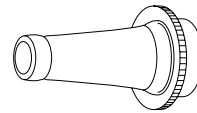

## Bruenings Anastigmatic Aural Magnifier

### Anastigmatic aural magnifier, acc. to Brünings

complete in wooden case

Delivery includes:

ear speculum size 0 (119610), size 1 (119601), size 2 (119602), size 3 (119603), magnifier head (119800), rubber bulb (119300)

WT119000 Anastigmatic aural magnifier, acc. to Brünings, Set L

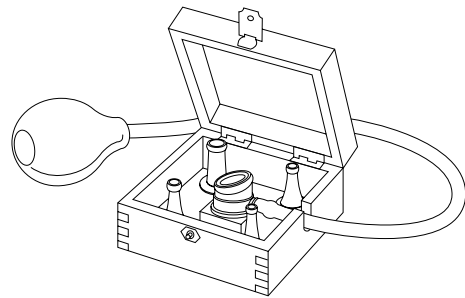



- Matt finished and ebony finished models
- Models for infants and adults
- Models with round and oval oblique end

**EXPLORENT**

## Hartmann Ear Specula

### Ear speculum, acc. to Hartmann

stainless steel, matt finish,  
36 mm length,  
various diameters (mm)

- WT118000 Ear speculum, acc. to Hartmann 1.8 x 36
- WT118001 Ear speculum, acc. to Hartmann 3.2 x 36
- WT118002 Ear speculum, acc. to Hartmann 4.0 x 36
- WT118003 Ear speculum, acc. to Hartmann 5.3 x 36
- WT118004 Ear speculum, acc. to Hartmann 6.5 x 36

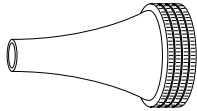

### Ear speculum, for postoperative treatment

matt finish, round, various inner diameters (mm)

- WT118101 Ear speculum, for postoperative treatment, size 8.0
- WT118102 Ear speculum, for postoperative treatment, size 9.0

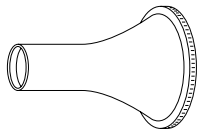

### Ear speculum, for postoperative treatment

ebony finish, round, 9 mm inner diameter

- WT118109 Ear speculum, for postoperative treatment,  
black, size 9

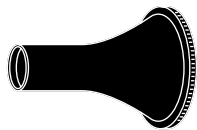

### Ear speculum, acc. to Hartmann

ebony finish, round  
various inner diameters (mm)

- WT118301 Ear speculum, acc. to Hartmann, black, size 3.0
- WT118302 Ear speculum, acc. to Hartmann, black, size 4.0
- WT118303 Ear speculum, acc. to Hartmann, black, size 5.0
- WT118304 Ear speculum, acc. to Hartmann, black, size 7.0

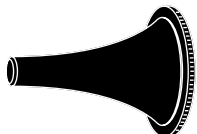

## Toynbee Ear Specula

### Ear speculum, acc. to Toynbee

matt finish, round, various inner diameters (mm)

- WT118401 Ear speculum, acc. to Toynbee, size 3.2
- WT118402 Ear speculum, acc. to Toynbee, size 4.0
- WT118403 Ear speculum, acc. to Toynbee, size 5.3

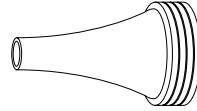

## Accessories

### Stand for speculum

140 mm length, 105 mm width, 50 mm height

- WT118612 Stand, for 12 ear speculum, size 140 x 105 x 50

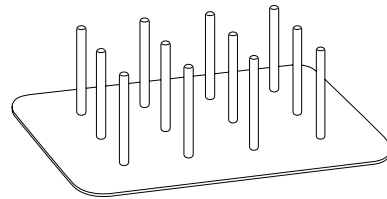

## Ear Specula

### Ear speculum, acc. to Politzer

infant type, matt finish, round,  
27 mm length, various inner diameters (mm)

- WT118201 Ear speculum, acc. to Politzer, short, size 2.0 x 27
- WT118202 Ear speculum, acc. to Politzer, short, size 3.0 x 27
- WT118203 Ear speculum, acc. to Politzer, short, size 4.0 x 27

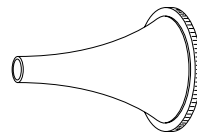



## Farrior Ear Specula

### Ear speculum, acc. to Farrior

stainless steel, special dull polish,  
round, regular end,  
various inner diameters (mm)

- WT216001 Ear speculum, acc. to Farrior, round, straight, size 4.5
- WT216002 Ear speculum, acc. to Farrior, round, straight, size 5.5
- WT216003 Ear speculum, acc. to Farrior, round, straight, size 6.5
- WT216004 Ear speculum, acc. to Farrior, round, straight, size 7.5
- WT216005 Ear speculum, acc. to Farrior, round, straight, size 8.5
- WT216006 Ear speculum, acc. to Farrior, round, straight, size 9.5
- WT216007 Ear speculum, acc. to Farrior, round, straight, size 10

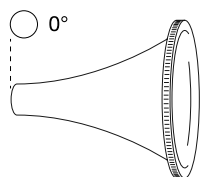

### Ear speculum, acc. to Farrior

stainless steel, black,  
round, regular end,  
various inner diameters (mm)

- WT216011 Ear speculum, acc. to Farrior, round, black, straight, size 4.5
- WT216012 Ear speculum, acc. to Farrior, round, black, straight, size 5.5
- WT216013 Ear speculum, acc. to Farrior, round, black, straight, size 6.5
- WT216014 Ear speculum, acc. to Farrior, round, black, straight, size 7.5
- WT216015 Ear speculum, acc. to Farrior, round, black, straight, size 8.5
- WT216016 Ear speculum, acc. to Farrior, round, black, straight, size 9.5
- WT216017 Ear speculum, acc. to Farrior, round, black, straight, size 10

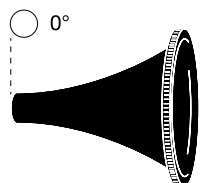

## Farrior Ear Specula (cont.)

### Ear speculum, acc. to Farrior

stainless steel, special dull polish,  
oval, 20° oblique end,  
various inner diameters (mm)

- WT216201 Ear speculum, acc. to Farrior, oval, oblique end 20, size 4.2 x 4.6
- WT216202 Ear speculum, acc. to Farrior, oval, oblique end 20, size 5.2 x 5.8
- WT216203 Ear speculum, acc. to Farrior, oval, oblique end 20, size 5.9 x 6.8
- WT216204 Ear speculum, acc. to Farrior, oval, oblique end 20, size 7.0 x 8.0
- WT216205 Ear speculum, acc. to Farrior, oval, oblique end 20, size 7.9 x 9.2
- WT216206 Ear speculum, acc. to Farrior, oval, oblique end 20, size 8.8 x 10.1
- WT216207 Ear speculum, acc. to Farrior, oval, oblique end 20, size 9.5 x 10.8

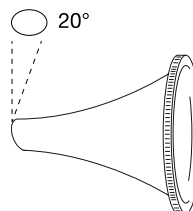

## Farrior Ear Specula (cont.)

### Ear speculum, acc. to Farrior

stainless steel, special dull polish,  
black, oval, 20° oblique end,  
various inner diameters (mm)

- WT216211 Ear speculum, acc. to Farrior, oval, black, oblique end 20, size 4.2 x 4.6
- WT216212 Ear speculum, acc. to Farrior, oval, black, oblique end 20, size 5.2 x 5.8
- WT216213 Ear speculum, acc. to Farrior, oval, black, oblique end 20, size 5.9 x 6.8
- WT216214 Ear speculum, acc. to Farrior, oval, black, oblique end 20, size 7.0 x 8.0
- WT216215 Ear speculum, acc. to Farrior, oval, black, oblique end 20, size 7.9 x 9.2
- WT216216 Ear speculum, acc. to Farrior, oval, black, oblique end 20, size 8.8 x 10.1
- WT216217 Ear speculum, acc. to Farrior, oval, black, oblique end 20, size 9.5 x 10

○ 20°

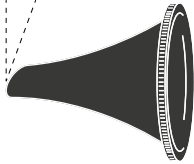

### Ear speculum, acc. to Farrior

stainless steel, special dull polish,  
oval, 35° oblique end,  
various inner diameters (mm)

- WT216401 Ear speculum, acc. to Farrior, oval, oblique end 35, size 4.2 x 4.6
- WT216402 Ear speculum, acc. to Farrior, oval, oblique end 35, size 5.2 x 5.8
- WT216403 Ear speculum, acc. to Farrior, oval, oblique end 35, size 5.9 x 6.8
- WT216404 Ear speculum, acc. to Farrior, oval, oblique end 35, size 7.0 x 8.0
- WT216405 Ear speculum, acc. to Farrior, oval, oblique end 35, size 7.9 x 9.2
- WT216406 Ear speculum, acc. to Farrior, oval, oblique end 35, size 8.8 x 10.1
- WT216407 Ear speculum, acc. to Farrior, oval, oblique end 35, size 9.5 x 10.8

○ 35°

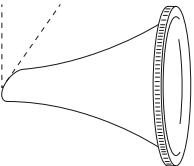

## Farrior Ear Specula (cont.)

### Ear speculum, acc. to Farrior

stainless steel, black,  
oval, 35° oblique end,  
various inner diameters (mm)

- WT216411 Ear speculum, acc. to Farrior, oval, black oblique end 35, size 4.2 x 4.6
- WT216412 Ear speculum, acc. to Farrior, oval, black oblique end 35, size 5.2 x 5.8
- WT216413 Ear speculum, acc. to Farrior, oval, black oblique end 35, size 5.9 x 6.8
- WT216414 Ear speculum, acc. to Farrior, oval, black oblique end 35, size 7.0 x 8.0
- WT216415 Ear speculum, acc. to Farrior, oval, black oblique end 35, size 7.9 x 9.2
- WT216416 Ear speculum, acc. to Farrior, oval, black oblique end 35, size 8.8 x 10.1
- WT216417 Ear speculum, acc. to Farrior, oval, black oblique end 35, size 9.5 x 10.8

○ 35°

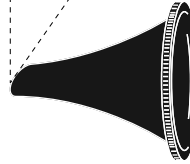



- Complete with holding rod for attachment to operating table
- With optional rotation clamp
- Optional ear speculum clamp and ear telescope clamp

**EXPLORENT**

## Flexible Tension Arm

### Articulated arm

complete with holding rod,  
for attachment to operating table

WT218800 Articulated arm, flexible, with holding rod

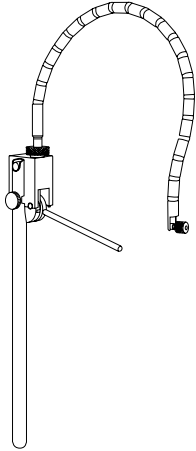

### Clamp socket

for articulated arm WT218800,  
attachable to operating table

WT218801 Clamp socket, for articulated arm WT218800

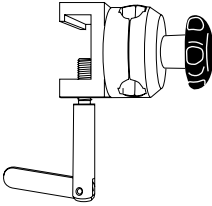

## Adapters for Flexible Tension Arm

WT218802 Adapter, ear speculum to articulated arm WT218800,  
size 120

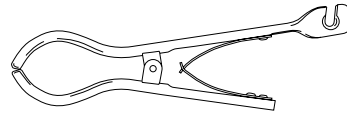

WT218803 Adapter, endoscope to articulated arm WT218800,  
size 80

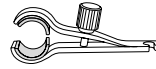



- Cotton applicators:  
serrated, triangular and twisted models,  
standard and very delicate models
- Ear Snare:  
angled model,  
snare wires cut and formed

**EXPLORENT**

## Cotton Applicators

### Cotton applicator

stainless steel, twisted end,  
very delicate, 0.7 mm diameter,  
various lengths (mm)

WT122411 Cotton applicator, with thread, size 0.7 x 110

WT122415 Cotton applicator, with thread, size 0.7 x 150



### Cotton applicator, acc. to Frohn

stainless steel, twisted end,  
various lengths (mm), 0.9 mm diameter,

WT122812 Cotton applicator, serrated, size 0.9 x 120

WT122814 Cotton applicator, serrated, size 0.9 x 140

WT122816 Cotton applicator, serrated, size 0.9 x 160

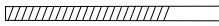

### Cotton applicator, acc. to Jobson-Horne

with curette, 18 cm total length

WT122718 Cotton applicator, acc. to Jobson-Horne,  
with curette, size 180



## Ear Snare

### Polyp snare, acc. to Krause

18 cm total length

WT137000 Polyp snare, acc. to Krause, size 180

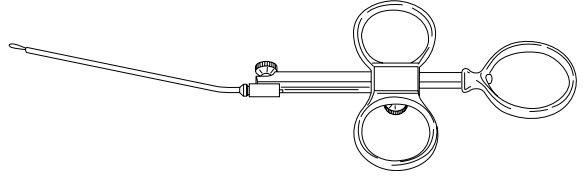

### Snare Wire

for polyp snare, shaped,  
for ear polypus snares, 0.2 mm diameter size

WT137500 Wire, for polyp snare, shaped, size 0.2, 100 pcs.

WT137600 Wire, for polyp snare, shaped, size 0.2, 12 pcs.

## Ear Probes, Loops, Curettes and Spatula

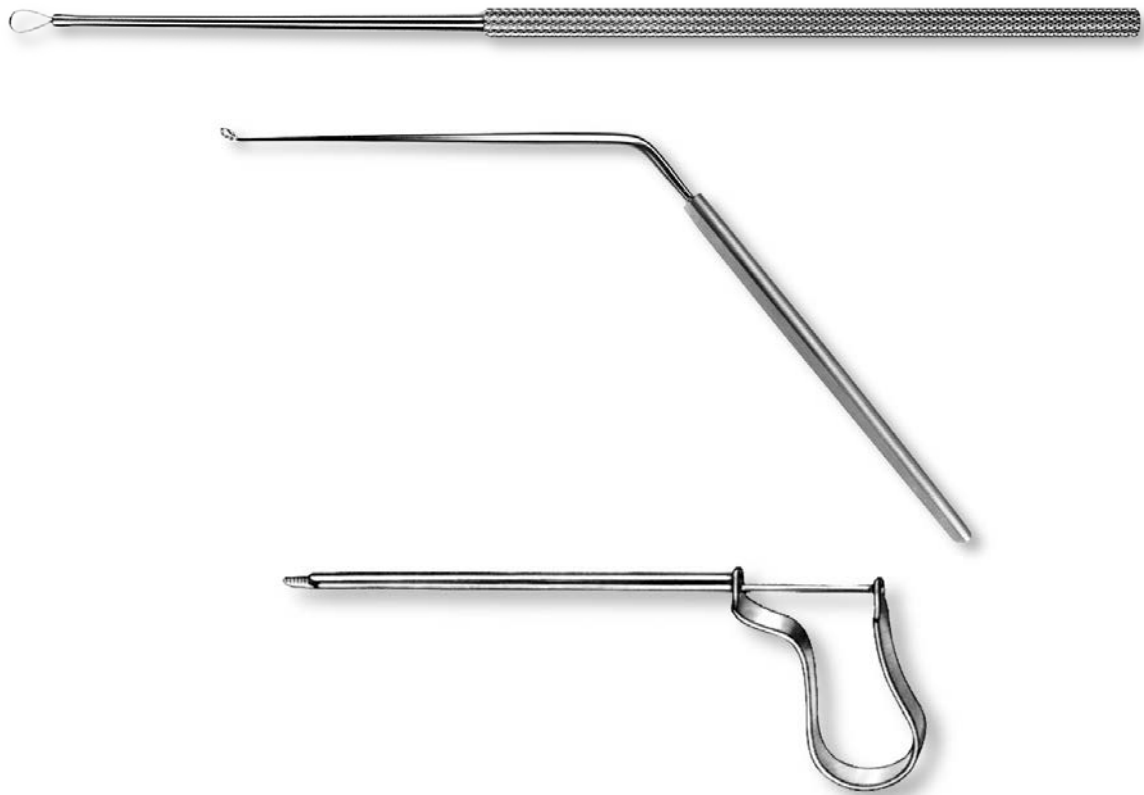

- Silver and silver plated probes
- Smooth and serrated ear loops
- Sharp and blunt ear curettes, straight and curved models
- Fine ear spatula and foreign body lever

**EXPLORENT**

## Probes

### Probe, acc. to Stacke

silver plated, 10 cm length

WT121000 Probe, acc. to Stacke, silver plated, size 100



### Probe, acc. to Stacke-Frenzel

silver, angled tip, 9 cm length, 1mm diameter

WT121200 Probe, acc. to Stacke-Frenzel, silver, curved, size 90

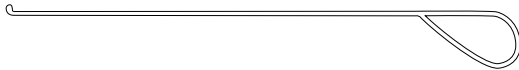

## Loops

### Loop, acc. to Billeau

straight, 16.5 cm total length, various loop sizes (mm)

WT123001 Loop, acc. to Billeau, straight, size 4.0 x 3.0 165

WT123002 Loop, acc. to Billeau, straight, size 6.0 x 3.5 165

WT123003 Loop, acc. to Billeau, straight, size 8.0 x 4.5 165



### Ear loop, acc. to Snellen

slight, curved,  
serrated, 15 cm total length, various loop sizes (mm)

WT123201 Ear loop, acc. to Snellen, serrated, curved, size 3.0 x 150

WT123202 Ear loop, acc. to Snellen, serrated, curved, size 4.0 x 150

WT123203 Ear loop, acc. to Snellen, serrated, curved, size 4.5 x 150

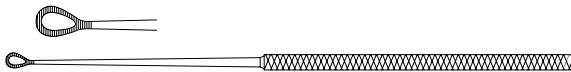

## Spatula

### Spatula, acc. to Zaufal

16 cm total length, 3 mm width

WT124100 Spatula, acc. to Zaufal, curved, size 160

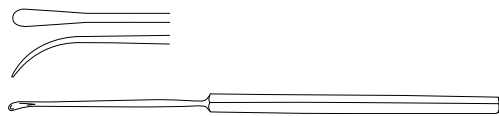

## Curettes

### Ear curette, acc. to Shapleigh

slight, curved, serrated,  
16.5 cm total length, various curette widths (mm)

WT123301 Ear curette, acc. to Shapleigh, serrated,  
curved, size 2.6 x 165

WT123302 Ear curette, acc. to Shapleigh, serrated,  
curved, size 3.0 x 165

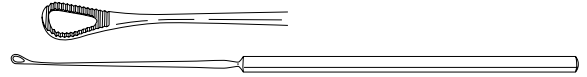

### Ear curette, acc. to Buck

blunt, 15 cm total length, various curette sizes (mm)

WT125020 Ear curette, acc. to Buck, blunt, size 00, 1.6 x 150

WT125010 Ear curette, acc. to Buck, blunt, size 0, 2.0 x 150

WT125001 Ear curette, acc. to Buck, blunt, size 1, 2.8 x 150

WT125002 Ear curette, acc. to Buck, blunt, size 2, 3.2 x 150

WT125003 Ear curette, acc. to Buck, blunt, size 3, 3.5 x 150

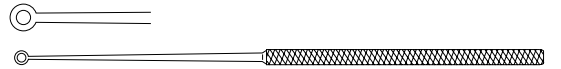

### Ear curette, acc. to Buck

sharp, 15 cm total length, various curette sizes (mm)

WT125120 Ear curette, acc. to Buck, sharp, size 00, 1.6 x 150

WT125110 Ear curette, acc. to Buck, sharp, size 0, 2.0 x 150

WT125101 Ear curette, acc. to Buck, sharp, size 1, 2.8 x 150

WT125102 Ear curette, acc. to Buck, sharp, size 2, 3.2 x 150

WT125103 Ear curette, acc. to Buck, sharp, size 3, 3.5 x 150

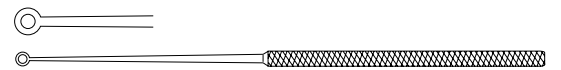

### Ear curette

angled, blunt,  
35° up-curved

WT125300 Ear curette, blunt, angled, up-curved, size 2.5

WT125301 Ear curette, blunt, angled, up-curved, size 2.8

WT125302 Ear curette, blunt, angled, up-curved, size 3.5

WT125303 Ear curette, blunt, angled, up-curved, size 3.8

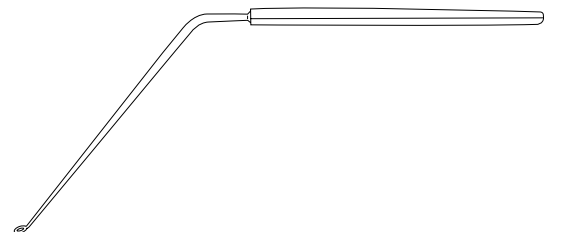





**EXPLORENT**

- Standard models
- Double-ended model with hook and spoon

## Ear Hooks

### Ear hook, acc. to Day

14.5 cm total length, various hook sizes (mm)

WT123401 Ear hook, acc. to Day, size 2.0 x 145

WT123402 Ear hook, acc. to Day, size 3.0 x 145



### Ear hook, acc. to Lucae

14.5 cm total length, various hook sizes (mm)

WT123501 Ear hook, acc. to Lucae, with ball end, size 2.0 x 145

WT123502 Ear hook, acc. to Lucae, with ball end, size 2.5 x 145

WT123503 Ear hook, acc. to Lucae, with ball end, size 3.5 x 145

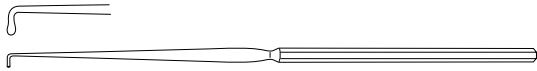

### Ear hook, acc. to Wagener

15 cm total length, various hook sizes (mm)

WT123601 Ear hook, acc. to Wagener, size 2.0 x 150

WT123602 Ear hook, acc. to Wagener, size 2.5 x 150

WT123603 Ear hook, acc. to Wagener, size 3.0 x 150

WT123604 Ear hook, acc. to Wagener, size 3.5 x 150

WT123605 Ear hook, acc. to Wagener, size 4.5 x 150



### Hook, acc. to Gross

with spoon, 1.5 mm hook, sharp,  
13 cm total length, 9 x 4 mm spoon

WT123900 Hook, acc. to Gross, with spoon, size 130

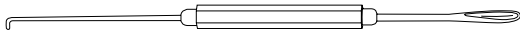

## Myringotomy Knives, Tympanum Perforators

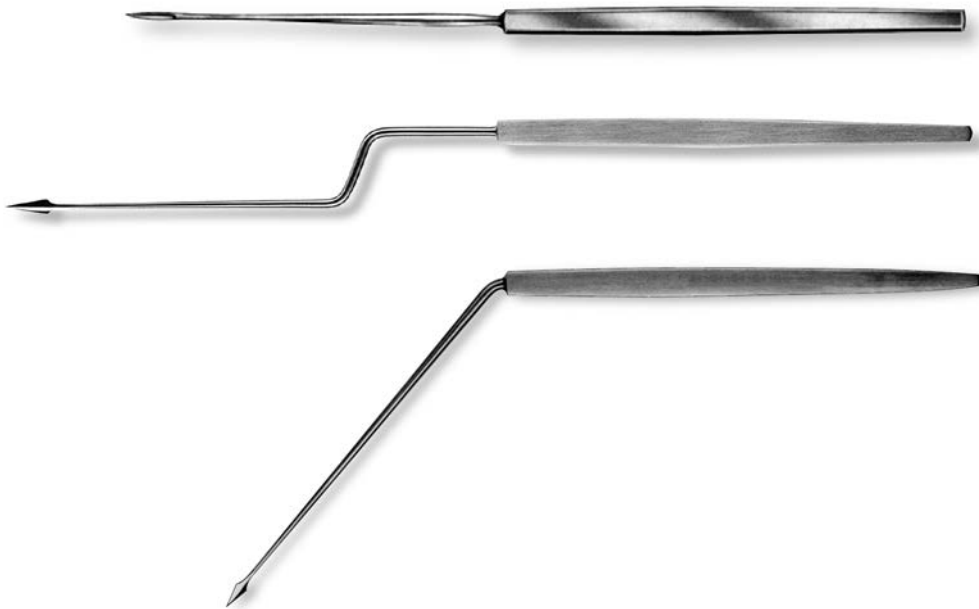

- Straight, angled, curved and bajonet shaped models
- Perforators with detachable tips
- Up- and downcutting models

**EXPLORENT**

## Tympanum Perforators

### Perforator, acc. to Politzer

angled, for tympanum,  
16 cm total length

WT133000 Perforator, acc. to Politzer, for tympanum, angled, size 160

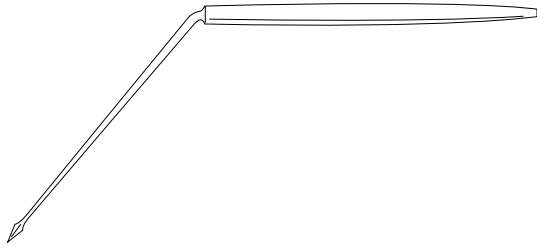

### Perforator, acc. to Lucae

bayonet, for tympanum,  
18.5 cm total length

WT134000 Perforator, acc. to Lucae, for tympanum,  
bayonet shaped, size 185

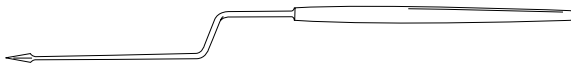

## Myringotomy Knives

### Knife

for myringotomy, straight,  
16.5 cm total length

WT133100 Knife, for myringotomy, straight, size 165



### Knife, acc. to Royce

angled,  
16 cm total length

WT133400 Knife, acc. to Royce, upwards cutting, curved, size 160

WT133500 Knife, acc. to Royce, downward cutting, curved, size 160

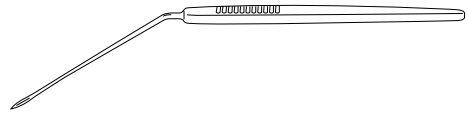

### Ear knife, acc. to Politzer

16 cm total length

WT134701 Ear knife, acc. to Politzer, straight, size 160

WT134702 Ear knife, acc. to Politzer, curved, size 160

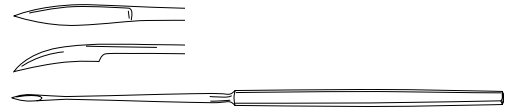



- Standard and micro suction models
- Angled and curved models
- Stainless steel and silver models
- Different adapters

**EXPLORENT**

## Suction Tubes

### Suction tube, acc. to Verhoeven

9 cm working length, various diameters

- WT135200 Suction tube, acc. to Verhoeven, straight, size 2.0 x 90  
 WT135300 Suction tube, acc. to Verhoeven, straight, size 1.5 x 90

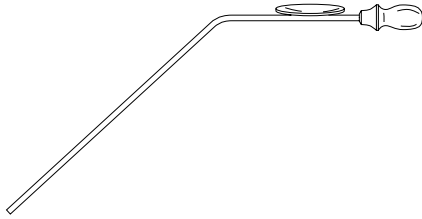

### Suction tube, acc. to Nijmegen

7.5 cm working length, various diameters

- WT136015 Suction tube, acc. to Nijmegen, size 1.5 x 75  
 WT136020 Suction tube, acc. to Nijmegen, size 2.0 x 75  
 WT136025 Suction tube, acc. to Nijmegen, size 2.5 x 75  
 WT136030 Suction tube, acc. to Nijmegen, size 3.0 x 75  
 WT136040 Suction tube, acc. to Nijmegen, size 4.0 x 75

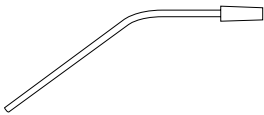

### Suction tube, acc. to Barnes, Luer connection

5 cm working length, with cut-off, various diameters

- WT136615 Suction tube, acc. to Barnes, Luer connection, size 1.5 x 50  
 WT136617 Suction tube, acc. to Barnes, Luer connection, size 1.7 x 50  
 WT136620 Suction tube, acc. to Barnes, Luer connection, size 2.0 x 50

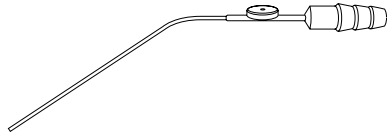

## Suction Tubes (cont.)

### Suction tube, curved, with Luer conus

curved, cylindric, Luer,  
 10.5 cm working length, various diameters

- WT136510 Suction tube, curved, with Luer conus, size 1.0 x 105  
 WT136515 Suction tube, curved, with Luer conus, size 1.5 x 105  
 WT136520 Suction tube, curved, with Luer conus, size 2.0 x 105  
 WT136530 Suction tube, curved, with Luer conus, size 3.0 x 105  
 WT136540 Suction tube, curved, with Luer conus, size 4.0 x 105  
 WT136550 Suction tube, curved, with Luer conus, size 5.0 x 105

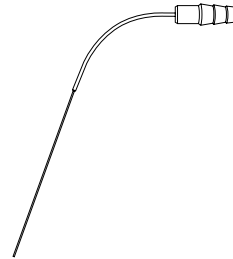

### Suction tube, acc. to House

7 cm working length, 10 cm total, various diameters

- WT266106 Suction tube, acc. to House, with Luer-lock, curved, size 0.6 x 70  
 WT266108 Suction tube, acc. to House, with Luer-lock, curved, size 0.8 x 70  
 WT266110 Suction tube, acc. to House, with Luer-lock, curved, size 1.0 x 70  
 WT266112 Suction tube, acc. to House, with Luer-lock, curved, size 1.2 x 70  
 WT266115 Suction tube, acc. to House, with Luer-lock, curved, size 1.5 x 70  
 WT266118 Suction tube, acc. to House, with Luer-lock, curved, size 1.8 x 70  
 WT266120 Suction tube, acc. to House, with Luer-lock, curved, size 2.0 x 70  
 WT266122 Suction tube, acc. to House, with Luer-lock, curved, size 2.2 x 70  
 WT266125 Suction tube, acc. to House, with Luer-lock, curved, size 2.5 x 70  
 WT266130 Suction tube, acc. to House, with Luer-lock, curved, size 3.0 x 70

## Suction Tubes (cont.)

### Suction tube, acc. to Baron

7.5 cm working length, 14 cm total, various diameters

- WT134803 Suction tube, acc. to Baron, with cut-off, size 1.0 x 75
- WT134805 Suction tube, acc. to Baron, with cut-off, size 1.7 x 75
- WT134807 Suction tube, acc. to Baron, with cut-off, size 2.3 x 75

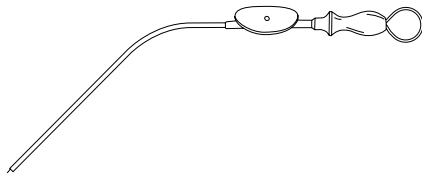

### Suction tube, acc. to Frazier

9 cm working length, various diameters

- WT210006 Suction tube, acc. to Frazier, with cut-off, size 2.0 x 90
- WT210008 Suction tube, acc. to Frazier, with cut-off, size 2.7 x 90
- WT210010 Suction tube, acc. to Frazier, with cut-off, size 3.3 x 90
- WT210012 Suction tube, acc. to Frazier, with cut-off, size 4.0 x 90
- WT210015 Suction tube, acc. to Frazier, with cut-off, size 5.0 x 90

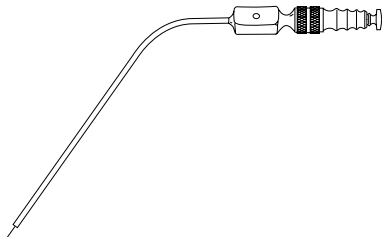

### Suction/irrigation tube, acc. to House

9 cm working length, 16 cm total length

- WT268501 Suction/irrigation tube, acc. to House, size 4.5 x 2.0, 90
- WT268502 Suction/irrigation tube, acc. to House, size 3.0 x 2.0, 90
- WT268503 Suction/irrigation tube, acc. to House, size 2.5 x 2.0, 90
- WT268504 Suction/irrigation tube, acc. to House, size 1.8 x 1.8, 90
- WT268505 Suction/irrigation tube, acc. to House, size 1.5 x 1.5, 90
- WT268506 Suction/irrigation tube, acc. to House, size 1.2 x 0.9, 90
- WT268507 Suction/irrigation tube, acc. to House, size 0.9 x 0.7, 90

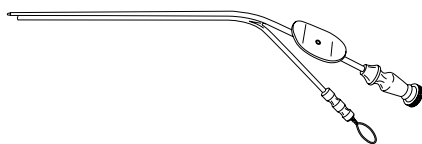

## Suction Tubes (cont.)

### Suction tube, acc. to Schuhknecht

Luer, 7 cm working length,  
tapered tip, with wire, 14 cm total length  
diameters (mm)

- WT269020 Suction tube, acc. to Schuhknecht, with Luer cone size 0.9 x 70
- WT269024 Suction tube, acc. to Schuhknecht, with Luer cone size 0.6 x 70

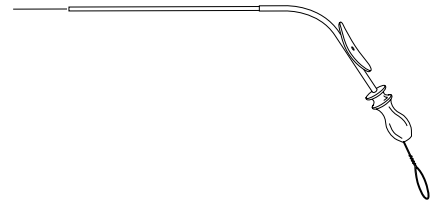

## Zoellner Suction Tubes

### Suction tube, acc. to Zoellner

Luer, 2.4 mm diameter, 14 cm working length

- WT268000 Suction tube, acc. to Zoellner, size 2.4 x 140, with tip WT268107

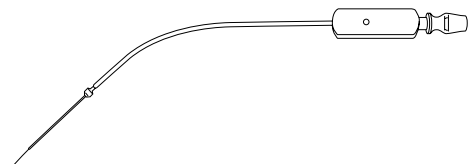

### Suction tube, tip, acc. to Zoellner

micro suction cannula to slip on Zoellner suction tube,  
with wire, various diameters (mm)

- WT268105 Suction tube, tip, acc. to Zoellner, size 0.5
- WT268106 Suction tube, tip, acc. to Zoellner, size 0.6
- WT268107 Suction tube, tip, acc. to Zoellner, size 0.7
- WT268108 Suction tube, tip, acc. to Zoellner, size 0.8
- WT268109 Suction tube, tip, acc. to Zoellner, size 0.9
- WT268112 Suction tube, tip, acc. to Zoellner, size 1.2



## Adapters for Suction Tubes

### Adapter, acc. to Wullstein

stainless steel, Luer-cone, 11 cm total length

WT265002 Adapter, acc. to Wullstein, for suction tubes, Luer cone

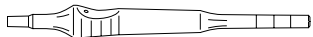

### Adapter, acc. to House

Luer-cone, 5.2 cm total length

WT265502 Adapter, acc. to House, with Luer cone, size 52







- Single- and double-ended models
- Large and delicate models
- Oval curettes

## EXPLORENT

## Single-Ended Elevators

### Elevator, acc. to Adson

straight,  
17 cm total length, 8 mm width

WT205500 Elevator, acc. to Adson, straight, size 8.0 x 170

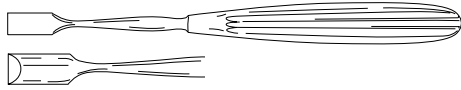

### Raspatory, acc. to Jansen

19.5 cm total length, various widths (mm)

WT205609 Raspatory, acc. to Jansen, size 9.0 x 195

WT205614 Raspatory, acc. to Jansen, size 14 x 195



### Raspatory, acc. to Eicken

19.5 cm total length, 6 mm width

WT205706 Raspatory, acc. to Eicken, size 6.0 x 195

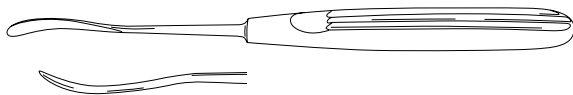

### Raspatory, acc. to Lempert (Joseph)

17.5 cm total length, various widths (mm)

WT208001 Raspatory, acc. to Lempert (Joseph),  
slightly curved, size 2.0 x 175

WT208002 Raspatory, acc. to Lempert (Joseph),  
slightly curved, size 3.0 x 175

WT208003 Raspatory, acc. to Lempert (Joseph),  
slightly curved, size 4.0 x 175

WT208004 Raspatory, acc. to Lempert (Joseph),  
slightly curved, size 5.0 x 175

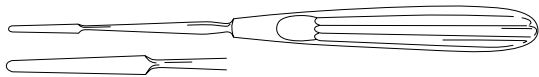

### Raspatory, acc. to Wullstein

16.5 cm total length

WT261500 Raspatory, acc. to Wullstein, delicate, curved, size 165

WT261501 Raspatory, acc. to Wullstein, large, curved, size 165

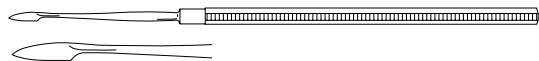

## Single-Ended Elevators (2)

### Raspatory, acc. to Shambough-Derlacki

16.5 cm total length, 3 mm width

WT261600 Raspatory, acc. to Shambough-Derlacki,  
Duckbill shape, size 3.0 x 165



### Raspatory, acc. to Plester

18 cm total length, 8 mm width

WT261700 Raspatory, acc. to Plester, size 8.0 x 180



### Raspatory, acc. to Fisch

17 cm total length, 10 mm width

WT261800 Raspatory, acc. to Fisch, size 10 x 170



## Double-Ended Elevators

### Elevator, acc. to Freer

double-ended, sharp/blunt, 20 cm total length,  
USA model, 4.5 mm width

WT315000 Elevator, acc. to Freer, double-ended,  
american type, size 200



### Elevator, acc. to Freer

double-ended, sharp/blunt, 18 cm total length  
4.7 mm width

WT315100 Elevator, acc. to Freer, double-ended,  
sharp/blunt, size 180



## Raspatories

### Raspatory, acc. to Farabeuf

various widths and total lengths (mm)

- WT205000 Raspatory, acc. to Farabeuf, straight, size 13 x 150
- WT205100 Raspatory, acc. to Farabeuf, curved, size 13 x 150
- WT205111 Raspatory, acc. to Farabeuf, curved, size 11 x 175

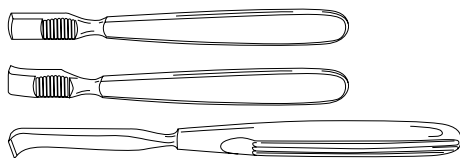

## Sharp Curettes

### Curette, acc. to Spratt

17 cm total length, various curette sizes (mm)



- WT242000 Curette, acc. to Spratt, oval, size 0, 3.5 x 5.5 170
- WT242001 Curette, acc. to Spratt, oval, size 1, 4.5 x 7.0 170
- WT242002 Curette, acc. to Spratt, oval, size 2, 5.5 x 8.0 170



### Curette, acc. to Lempert

oval, various curette sizes,  
21 cm total length,

- WT243010 Curette, acc. to Lempert, oval, size 0, 3.9 x 6.3 210
- WT243020 Curette, acc. to Lempert, oval, size 2/0, 3.5 x 5.3 210
- WT243030 Curette, acc. to Lempert, oval, size 3/0, 2.9 x 4.3 210
- WT243040 Curette, acc. to Lempert, oval, size 4/0, 2.0 x 3.5 210
- WT243050 Curette, acc. to Lempert, oval, size 5/0, 2.0 x 2.9 210

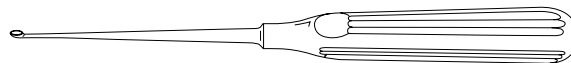



## Benedict Instruments for Anthelix Scoring

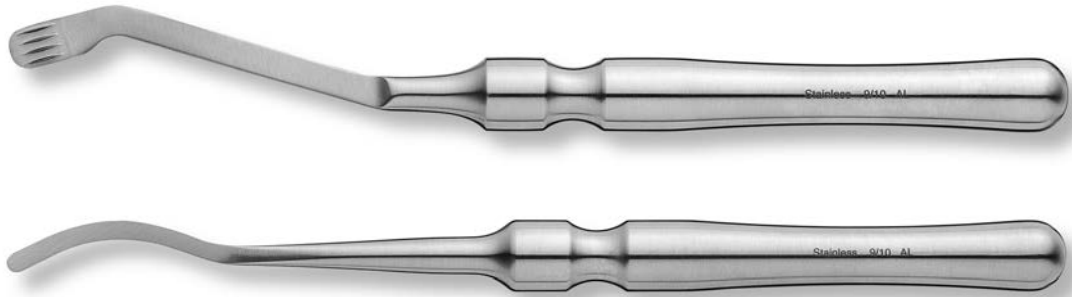

The minimally invasive otoplasty (MIO) technique has met worldwide increasing interest in the last years; it is now well established as an elegant alternative to the open otoplasty techniques. These surgical instruments were specially designed for the minimally invasive otoplasty, but they can be used in open otoplasty as well. The elevator serves for tunneling the anthelical perichondrium and the scoring instrument for weakening of the anthelical cartilage. During most otoplasties the cartilage is usually being scored with a scalpel knife. In comparison with the scalpel method the Benedict type scoring instrument allows more precise and defined scoring of the cartilage. Synchronous scoring is effected by four parallel identical microblades. The depth of scoring is thereby exactly defined; this helps to prevent visible cartilage cutting edges. The slender and curved design of the instruments corresponds to the shape of the auricle. Reference: Dr. M. Benedict, Ettlingen, Germany

- Scoring instrument sets for right and left ear, for the anthelical weakening
- Elevators for right and left ear of the subperichondrial tunnel
- Instruments are usable for minimally invasive and for open otoplasty techniques

**EXPLORENT**

## Benedict Scoring Instruments

### Scoring instrument, acc. to Benedict

for otoplasty, set

- Delivery includes: WT290001, WT290002

WT290000 Scoring instrument, acc. to Benedict, for otoplasty, set

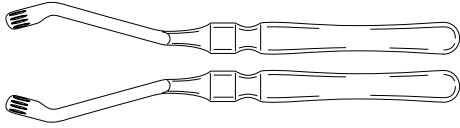

### Scoring instrument, acc. to Benedict

4 blades, 6 mm width,  
15.7 cm total length

WT290001 Scoring instrument, acc. to Benedict, right,  
four-blades, size 6.0 x 157

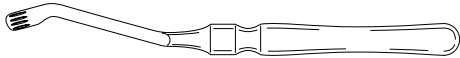

WT290002 Scoring instrument, acc. to Benedict, left,  
four-blades, size 6.0 x 157

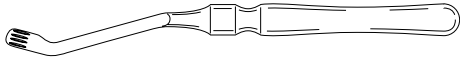

## Benedict Elevators

### Elevator, acc. to Benedict

for otoplasty, set

- Delivery includes: WT290006, WT290007

WT290005 Elevator, acc. to Benedict, Set, curved left and right

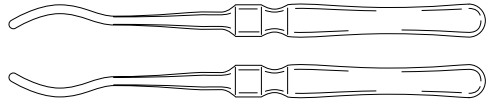

### Elevator, acc. to Benedict

working part round curved 3.3 cm,  
16 cm total length

WT290006 Elevator, acc. to Benedict, curved right, size 160

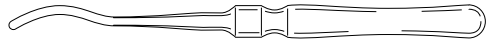

WT290007 Elevator, acc. to Benedict, curved left, size 160



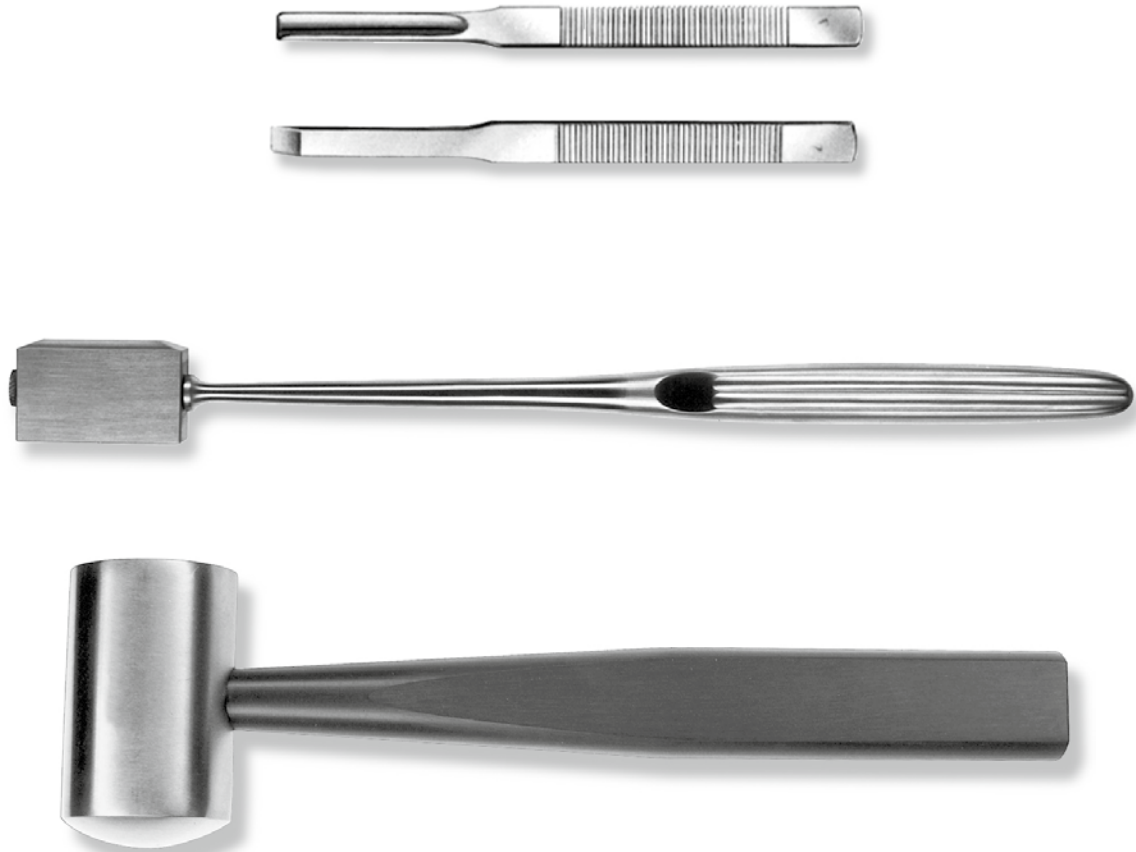

- Chisels and gouges with different width
- Chisels especially for haemostatis
- Mallets with different weights
- Mallet with replaceable nylon caps

**EXPLORENT**

## Ear Chisels and Gouges

### Gouge, acc. to Partsch

14 cm total length, various widths (mm)

- WT220002 Gouge, acc. to Partsch (Trautmann), size 2.2 x 140  
 WT220004 Gouge, acc. to Partsch (Trautmann), size 4.0 x 140  
 WT220006 Gouge, acc. to Partsch (Trautmann), size 6.0 x 140  
 WT220008 Gouge, acc. to Partsch (Trautmann), size 8.0 x 140  
 WT220010 Gouge, acc. to Partsch (Trautmann), size 10 x 140



### Chisel, acc. to Partsch (Trautmann)

14 cm total length, various widths (mm)

- WT220102 Chisel, acc. to Partsch (Trautmann), size 2.0 x 140  
 WT220104 Chisel, acc. to Partsch (Trautmann), size 4.0 x 140  
 WT220106 Chisel, acc. to Partsch (Trautmann), size 6.0 x 140

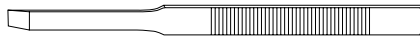

### Gouge, acc. to Heermann

for partial resection of the bony posterior aural meatus and the lateral attic wall, curved, 11 cm total length, various widths (mm)

- WT264010 Gouge, acc. to Heermann, curved, size 1.0 x 110  
 WT264015 Gouge, acc. to Heermann, curved, size 1.5 x 110  
 WT264030 Gouge, acc. to Heermann, curved, size 3.0 x 110

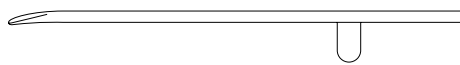

## Mallet with Replaceable Caps

### Mallet

with replaceable polyamide caps, flat/flat face, 212 g, 18 cm length, 25 mm diameter

- WT413500 Mallet, metal, light handle, size 180

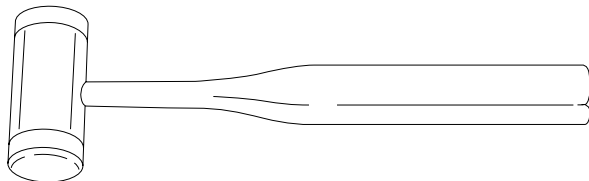

- WT413501 Spare mallet heads, polyamide

• 2 pcs.



## Mallets

### Mallet, acc. to Hajek

round/flat face, solid, 200 g, 20 cm total length, 27 mm diameter

- WT230000 Mallet, acc. to Hajek, metal, size 200

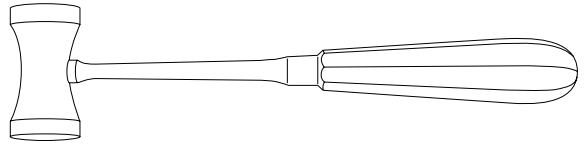

### Mallet, acc. to Cottle

round/flat face, 340 g, with black handle, 18 cm total length, 30 mm diameter

- WT413000 Mallet, acc. to Cottle, size 180

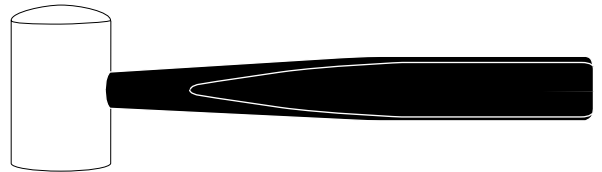

### Mallet, acc. to Heermann

various total length (mm)

- WT263500 Mallet, acc. to Heermann, large, size 220



- WT263501 Mallet, acc. to Heermann, small, size 170

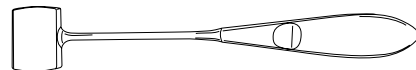





- Straight and curved models with slender and very delicate jaws
- Models with double-action transmission

**EXPLORENT**

## Rongeurs

### Bone rongeur, acc. to Luer

up-curved, 15 cm total length

WT231000 Bone rongeur, acc. to Luer, curved up, size 150

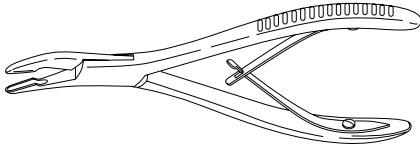

### Bone rongeur, acc. to Lempert

straight, slender,  
18.5 cm total length

WT232000 Bone rongeur, acc. to Lempert, slender, straight, size 185

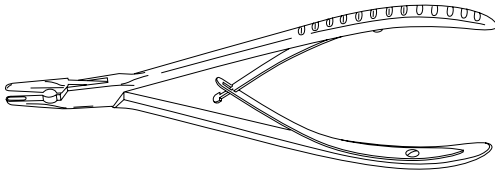

### Bone rongeur, acc. to Beyer

slight up-curved, long slender jaws,  
18 cm total length

WT233000 Bone rongeur, acc. to Beyer, curved up, size 180

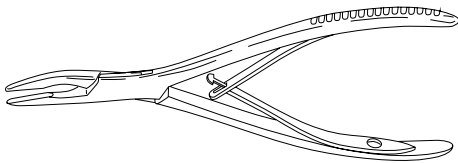

### Bone rongeur, acc. to Beyer

slight up-curved, double-action transmission,  
18 cm total length

WT234000 Bone rongeur, acc. to Beyer, double-action,

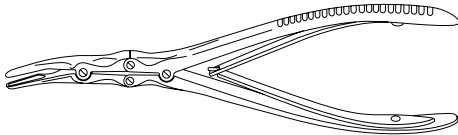

## Rongeurs

### Bone rongeur, acc. to Ruskin

slight up-curved, double-action transmission,  
18.5 cm total length

WT234200 Bone rongeur, acc. to Ruskin, double-action,  
curved up, size 185,  
slight up-curved,  
double-action transmission,  
curved, 19 cm

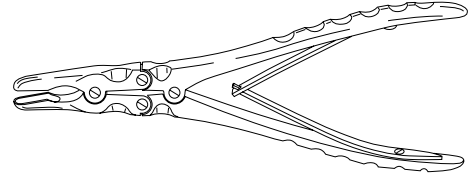

### Punch forceps, acc. to Kerrison

8 cm working length, various cutting widths (mm)

WT235000 Punch forceps, acc. to Kerrison, size 3.5 x 80

WT235001 Punch forceps, acc. to Kerrison, size 4.0 x 80

WT235002 Punch forceps, acc. to Kerrison, size 4.5 x 80

WT235003 Punch forceps, acc. to Kerrison, size 5.0 x 80

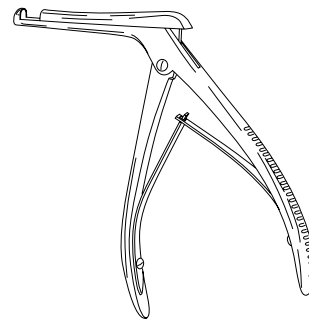



- Models with teeth, serrated and atraumatic jaws
- Slender and very delicate models, Jeweler micro forceps
- Ossicle forceps with fixation screw
- Slender and very delicate tampon forceps

**EXPLORENT**

## Dressing and Tissue Forceps

### Thumb forceps, acc. to Semken

serrated, delicate, straight, various total lengths (mm)

WT208612 Thumb forceps, acc. to Semken, delicate, size 125

WT208615 Thumb forceps, acc. to Semken, straight, size 150

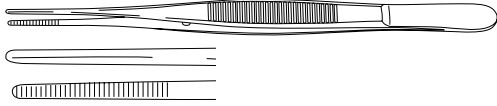

### Thumb forceps, for dissection, acc. to Semken

1 x 2 teeth, delicate, straight, various total lengths (mm)

WT208712 Thumb forceps, for dissection, acc. to Semken, delicate, size 125

WT208715 Thumb forceps, for dissection, acc. to Semken, straight, size 150

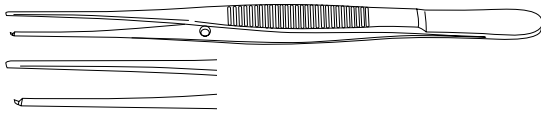

### Thumb forceps, acc. to McIndoe

serrated, straight, 15 cm total length

WT208915 Thumb forceps, acc. to McIndoe, size 150



### Thumb forceps

serrated, straight, 14.5 cm total length

WT209014 Thumb forceps, straight, size 145

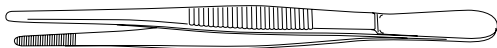

### Thumb forceps, for dissection

1 x 2 teeth, straight, 14.5 cm length

WT209114 Thumb forceps, for dissection, straight, size 145



### Thumb forceps, acc. to Graefe

delicate, serrated, 0.7 mm, 10 cm total length

WT209210 Thumb forceps, acc. to Graefe, straight, size 100

WT209220 Thumb forceps, acc. to Graefe, curved, size 0.7 x 100

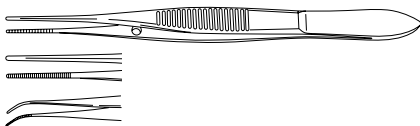

## Dressing and Tissue Forceps

### Thumb forceps, for dissection, acc. to Graefe,

delicate, 1 x 2 teeth, straight, 0.7 mm, 10 cm total length

WT209310 Thumb forceps, for dissection, acc. to Graefe, straight, size 100

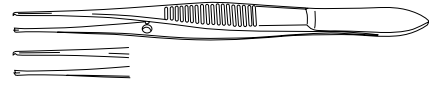

### Thumb forceps, for dissection, acc. to Gillies

1 x 2 teeth, serrated, 15 cm

WT209415 Thumb forceps, for dissection, acc. to Gillies, size 150

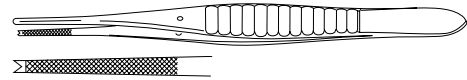

## Atraumatic, Dressing and Tissue Forceps

### Thumb forceps, atraumatic, acc. to DeBakey

15 cm length, various widths (mm)

WT209516 Thumb forceps, atraumatic, acc. to DeBakey straight, size 1.5 x 150

WT209616 Thumb forceps, atraumatic, acc. to DeBakey straight, size 2.0 x 150

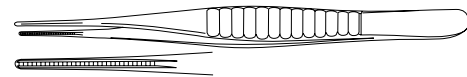

### Thumb forceps

pointed, straight, 11 cm length

WT209711 Thumb forceps, delicate, pointed, straight, size 110

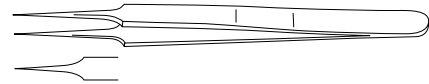

WT272000 Thumb forceps, for ossicles, acc. to Derlacki ossicle holding, 12.5 cm length

WT272000 Thumb forceps, for ossicles, acc. to Derlacki, with screw, size 125

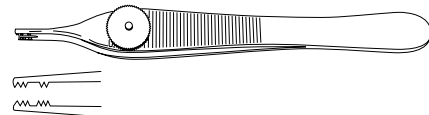

## Atraumatic, Dressing and Tissue Forceps (2)

**Thumb forceps, atraumatic, acc. to Helms**  
pointed, atraumatic, slender tip shape,  
15 cm total length

WT272200 Thumb forceps, atraumatic, acc. to Helms,  
pointed, size 150



**Thumb forceps, acc. to Adson**  
serrated, delicate, 12 cm total length

WT425112 Thumb forceps, acc. to Adson, size 120

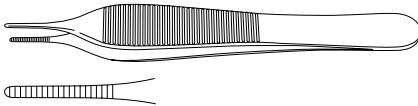

**Thumb forceps, for dissection, acc. to Adson**  
1 x 2 teeth, delicate, 12 cm total length

WT425212 Thumb forceps, for dissection, acc. to Adson,  
size 120

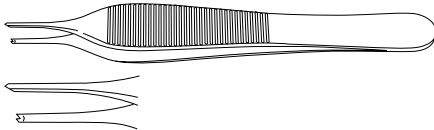

## Dressing Forceps

**Ear forceps, acc. to Hartmann**  
6 cm working length

WT131000 Ear forceps, acc. to Hartmann, slender, size 6

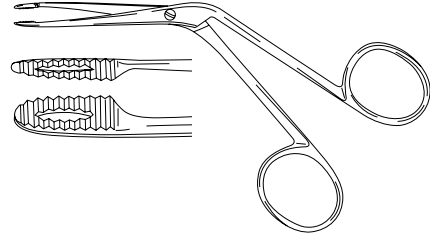

**Thumb forceps, acc. to Troeltsch (Wilde)**  
delicate, various total lengths (mm)

WT132011 Thumb forceps, acc. to Troeltsch (Wilde), size 110

WT132013 Thumb forceps, acc. to Troeltsch (Wilde), size 130

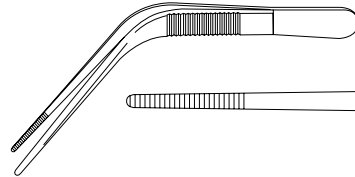

**Thumb forceps, acc. to Lucae**  
serrated, bayonet, 14 cm total length

WT132314 Thumb forceps, acc. to Lucae, size 140

WT132324 Thumb forceps, acc. to Lucae, bayonet shaped,  
narrow, size 140

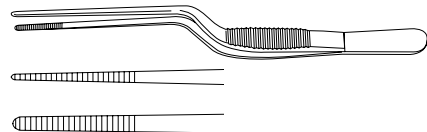

**Thumb forceps, acc. to Lucae**  
bayonet, 16 cm length

WT132316 Thumb forceps, acc. to Lucae, bayonet shaped, size 160

WT132326 Thumb forceps, acc. to Jansen, bayonet shaped,  
narrow, size 160







- With tungsten carbide cutting edges for extremely high durability
- Serrated blade models
- Delicate dissection models
- Wire cutter with serrated blades

## EXPLORENT

## Delicate Scissors

### Scissors

sharp/sharp, 9 cm total length

- WT277609 Iris scissors, sharp/sharp, straight, size 90  
WT277709 Iris scissors, sharp/sharp, curved up, size 90

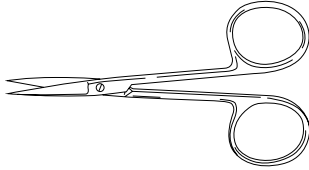

### Scissors

sharp/sharp, 10.5 cm total length

- WT277510 Iris scissors, sharp/sharp, straight, size 105  
WT277610 Iris scissors, sharp/sharp, curved up, size 105

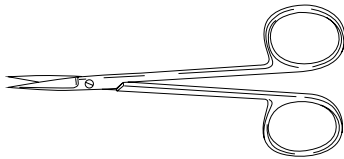

### Scissors

sharp/sharp, 11.5 cm total length

- WT277712 Iris scissors, sharp/sharp, straight, size 115  
WT277812 Scissors, sharp/sharp, curved up, size 115

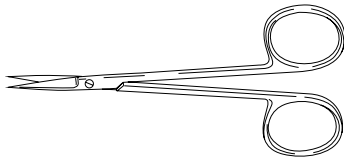

### Scissors

sharp/sharp, with tungsten carbide edges,  
11.5 cm total length

- WT277512 Iris scissors, sharp/sharp, with tungsten carbide,  
straight, size 115  
WT277612 Iris scissors, sharp/sharp, with tungsten carbide,  
curved up, size 115

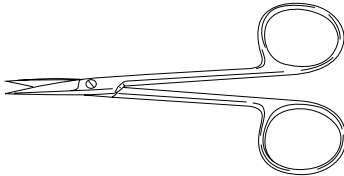

## Delicate Scissors (cont.)

### Scissors

sharp/sharp, delicate, curved, 12 cm total length

- WT183312 Scissors, fine, sharp/sharp, curved  
up, size 120

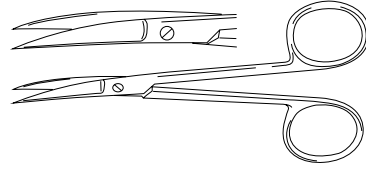

### Wire cutting scissors, acc. to Schuhknecht

serrated, 10 cm total length

- WT269500 Wire cutting scissors, acc. to Schuhknecht,  
serrated, size 100

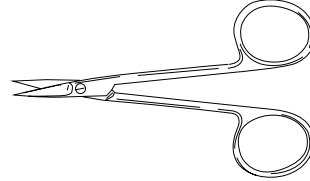

### Scissors, acc. to Joseph

sharp/sharp, 14 cm total length

- WT276514 Scissors, acc. to Joseph, straight, size 140  
WT276614 Scissors, acc. to Joseph, curved up, size 140

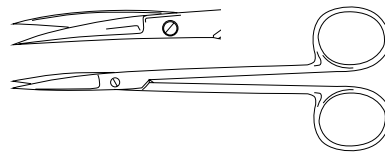

### Joseph scissors

sharp/sharp, with tungsten carbide edges,  
14 cm total length

- WT276714 Scissors, acc. to Joseph, with tungsten carbide,  
straight, size 140  
WT276814 Scissors, acc. to Joseph, with tungsten carbide  
curved up, size 140

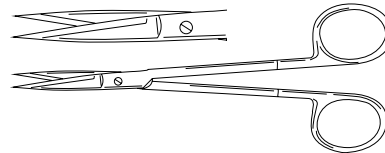



## Dissection Scissors

### Scissors

blunt/blunt, 10.5 cm length

WT277010 Strabismus scissors, blunt/blunt, straight, size 105

WT277110 Strabismus scissors, blunt/blunt, curved up, size 105

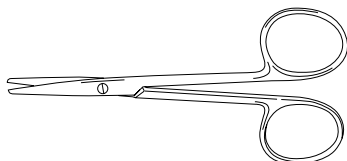

### Scissors

blunt/blunt, 11.5 cm total length

WT277212 Strabismus scissors, blunt/blunt, straight, size 115

WT277312 Strabismus scissors, blunt/blunt, curved up, size 115

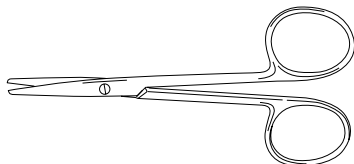

### Scissors

blunt/blunt, with tungsten carbide edges,  
11.5 cm total length

WT277012 Strabismus scissors, blunt/blunt,  
with tungsten carbide, straight, size 115

WT277112 Strabismus scissors, blunt/blunt,  
with tungsten carbide, curved up, size 115

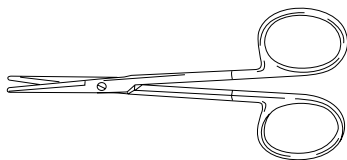

## Dissection Scissors (cont.)

### Dissection scissors, acc. to Kilner

curved, flat end, 13.5 cm total length,  
for elevation of the tympanic membrane

WT438714 Dissection scissors, acc. to Kilner,  
curved up, size 135

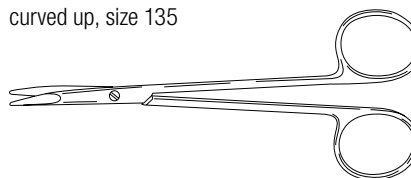

### Dissection scissors, acc. to Metzenbaum

14.5 cm total length

WT542014 Dissection scissors, acc. to Metzenbaum,  
curved up, size 145

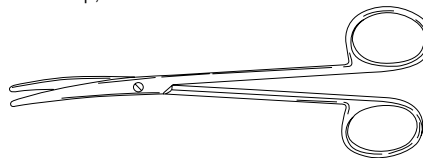

WT542214 Dissection scissors, acc. to Metzenbaum,  
with tungsten carbide, curved up, size 145

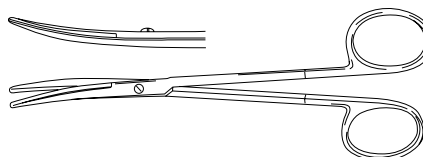

### Dissection scissors, acc. to Lexer

delicate, various total lengths (mm)

WT212216 Dissection scissors, acc. to Lexer-Fino, straight, size 165

WT212316 Dissection scissors, acc. to Lexer-Fino, curved up, size 165

WT212326 Dissection scissors, acc. to Mayo-Lexer,  
with tungsten carbide, curved up, size 160

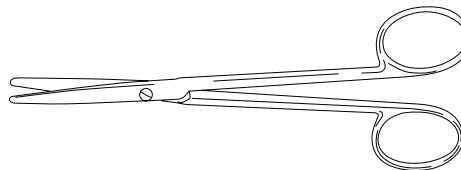



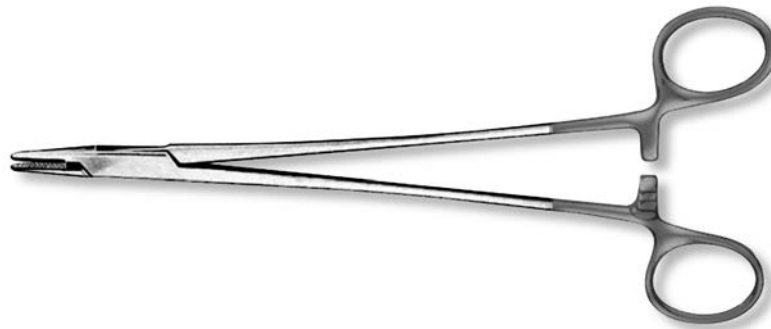

**EXPLORENT**

- With tungsten carbide inserts for extremely high durability

## Needle Holder

**Needle holder, acc. to Crile-Wood**  
with tungsten carbide inserts, straight,  
15 cm total length

WT213015 Needle holder, acc. to Crile-Wood,  
with tungsten carbide, size 150

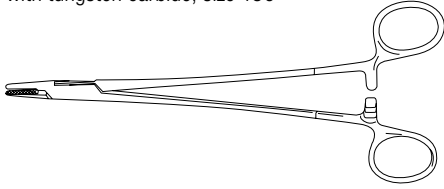



- Models with blunt and sharp prongs, long slender blades
- Self retaining and adjustable models

## EXPLORENT

## Wullstein Retractors

### Retractor, acc. to Wullstein

3 x 3 prongs, sharp or blunt type,  
11 cm total length

WT200011 Retractor, acc. to Wullstein, sharp,  
3 x 3 prongs, size 110

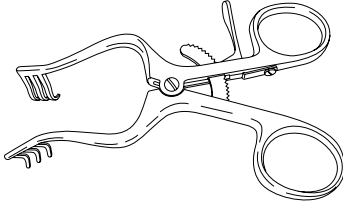

WT200111 Retractor, acc. to Wullstein, blunt,  
3 x 3 prongs, size 110

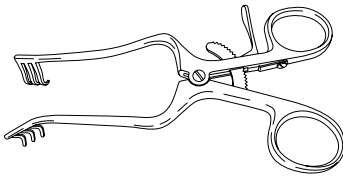

## Williger Retractor

### Retractor, acc. to Williger

4 prongs, sharp, 13 cm total length, 11.8 mm width

WT201400 Retractor, acc. to Williger, 4 prongs, sharp, size 130

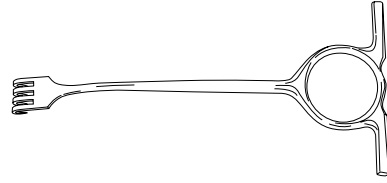

## Mini Retractor

### Retractor

4 x 4 prongs, blunt, delicate self-retaining,  
with ratchet crossed, 11 cm total length

WT201510 Retractor, acc. to Williger, 4 prongs, sharp, size 130

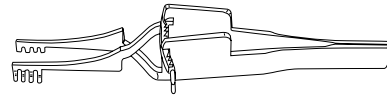

## Plester Retractors

### Retractor, acc. to Plester

2 x 2 prongs, sharp, 11 cm total length

WT201011 Retractor, acc. to Plester, 2 x 2 prongs, size 110

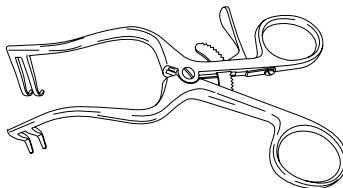

### Retractor, acc. to Plester

2 prongs, sharp, solid blade, 11 cm total length

WT201111 Retractor, acc. to Plester, 2 prongs right, size 110

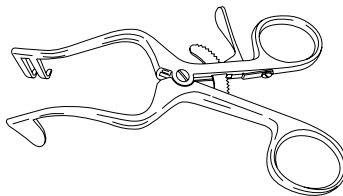

WT201211 Retractor, acc. to Plester, 2 prongs left, size 110

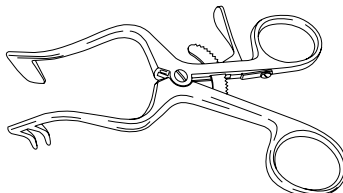

## Fisch Retractors

### Retractor, acc. to Fisch

2 x 2 prongs, sharp, 13 cm total length

WT201013 Retractor, acc. to Fisch, 2 x 2 prongs, size 130

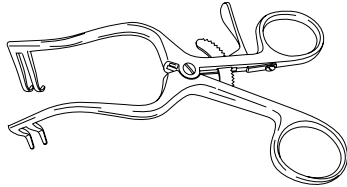

### Retractor, acc. to Fisch

3 x 3 prongs, 16.5 cm total length

WT202517 Retractor, acc. to Fisch, adjustable jaws,  
3 x 3 prongs, size 165

WT202518 Retractor, acc. to Fisch, adjustable jaws,  
blunt, 3 x 3 prongs, size 165

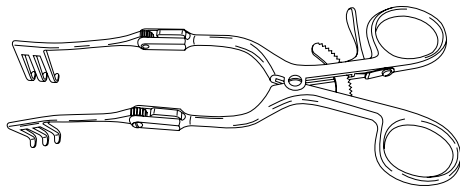

### Retractor, acc. to Fisch

3 prongs, blunt, solid blade, 16.5 cm total length

WT202617 Retractor, acc. to Fisch, adjustable jaws,  
3 prongs right, blade left, size 165

WT202717 Retractor, acc. to Fisch, adjustable jaws,  
3 prongs left, blade right, size 165

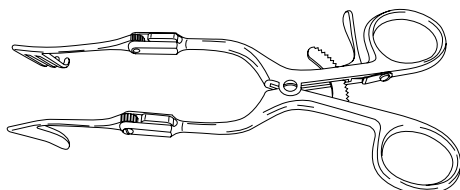







## EXPLORENT

- Round, lancet, flap and sickle knife models
- Straight, curved and angled models

## Micro Ear Knives



### Round knife, acc. to Rosen

45° angled, various diameters (mm)



WT250001	Round knife, acc. to Rosen, angled 45, size 2.5
WT250002	Round knife, acc. to Rosen, angled 45, size 2.3
WT250003	Round knife, acc. to Rosen, angled 45, size 2.0
WT250004	Round knife, acc. to Rosen, angled 45, size 1.8
WT250005	Round knife, acc. to Rosen, angled 45, size 1.5
WT250006	Round knife, acc. to Rosen, angled 45, size 1.2
WT250007	Round knife, acc. to Rosen, angled 45, size 1.0

### Rosen round knife

straight, various diameters (mm)



WT250011	Round knife, acc. to Rosen, straight, size 2.5
WT250012	Round knife, acc. to Rosen, straight, size 2.3
WT250013	Round knife, acc. to Rosen, straight, size 2.0
WT250017	Round knife, acc. to Rosen, straight, size 1.0

### Lancet knife, acc. to Rosen

16.5 cm total length



WT251000	Lancet knife, acc. to Rosen, size 165
----------	---------------------------------------

### Incision knife, acc. to Plester

16.5 cm total length



WT251500	Incision knife, acc. to Plester, size 2.5 x 165, 16.5 cm
----------	--

### Roller knife, acc. to Schuhknecht

16.5 cm total length, various cutting types, 3.5 mm diameter

WT252000	Roller knife, acc. to Schuhknecht, vertical cutting, size 165
WT252100	Roller knife, acc. to Schuhknecht, horizontal cutting, size 165



## Micro Ear Knives (cont.)

### Sickle knife, acc. to Wullstein

straight, 16.5 cm total length, 8 mm blade



WT253500	Sickle knife, acc. to Wullstein, straight, size 165
----------	---

### Sickle knife, acc. to Plester

curved, 16.5 cm total length

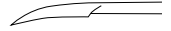

WT253600	Sickle knife, acc. to Plester, straight, size 165
----------	---

### Sickle knife, acc. to Plester

curved, very delicate, 16.5 cm total length, 5 mm blade



WT253700	Sickle knife, acc. to Plester, delicate, size 165
----------	---

### Sickle knife, acc. to Fisch

16 cm total length

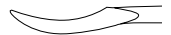

WT263005	Sickle knife, acc. to Fisch, size 160
----------	---------------------------------------





## EXPLORENT

- Straight, curved and angled models
- Delicate perforator models

## Needles



### Needle, acc. to Wullstein

straight, 16.5 cm total length



- WT254000 Needle, acc. to Wullstein, sharp, straight, size 165
- WT254100 Needle, acc. to Wullstein, blunt, straight, size 165

### Needle, acc. to Wullstein

slight curved, 16.5 cm total length



- WT254200 Needle, acc. to Wullstein, sharp, slightly curved, size 165
- WT254300 Needle, acc. to Wullstein, blunt, slightly curved, size 165

### Needle, acc. to Wullstein

strongly curved, 16.5 cm total length



- WT254400 Needle, acc. to Wullstein, sharp, strongly curved, size 165
- WT254500 Needle, acc. to Wullstein, blunt, strongly curved, size 165

### Needle, acc. to Wullstein

very slight curved, 16.5 cm total length



- WT254600 Needle, acc. to Wullstein, sharp, very slightly curved, size 165
- WT254700 Needle, acc. to Wullstein, blunt, very slightly curved, size 165

## Picks



### Pick

micro, 90° angled, 16.5 cm total length, various sizes (mm)



- WT255002 Pick, micro, angled down 90, size 0.2 x 165
- WT255004 Pick, micro, angled down 90, size 0.4 x 165
- WT255006 Pick, micro, angled down 90, size 0.6 x 165
- WT255008 Pick, micro, angled down 90, size 0.8 x 165
- WT255010 Pick, micro, angled down 90, size 1.0 x 165

### Pick

micro, 45° angled, 16.5 cm total length, various sizes (mm)



- WT256002 Pick, micro, angled down 45, size 0.2 x 165
- WT256004 Pick, micro, angled down 45, size 0.4 x 165
- WT256006 Pick, micro, angled down 45, size 0.6 x 165
- WT256008 Pick, micro, angled down 45, size 0.8 x 165
- WT256010 Pick, micro, angled down 45, size 1.0 x 165
- WT256015 Pick, micro, angled down 45, size 1.5 x 165

## Perforators

### Hand perforator, acc. to Larkin

0.8 mm diameter, length 16 cm total length



- WT262502 Hand perforator, acc. to Larkin, size 0.8 x 160

### Perforator, acc. to Fisch

Fisch-type, 16 cm, various diameter (mm)



- WT263103 Perforator, acc. to Fisch, size 0.3 x 160
- WT263104 Perforator, acc. to Fisch, size 0.4 x 160
- WT263105 Perforator, acc. to Fisch, size 0.5 x 160
- WT263106 Perforator, acc. to Fisch, size 0.6 x 160



**EXPLORENT**

- Straight, curved and angled models

## Micro Hooks

**Hook, acc. to Zenner**  
double curved, 16.5 cm total length



WT256100 Hook, acc. to Zenner, for footplate,  
double curved, size 165

**Hook, acc. to Gerlach**  
16.5 cm

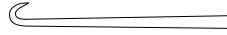

WT256200 Hook, acc. to Gerlach, size 165

**Hook, acc. to Plester**  
0.3 mm diameter, 16.5 cm total length

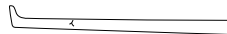

WT256700 Hook, acc. to Plester, for footplate, size 0.3 x 165

**Needle, acc. to Schuhknecht**  
straight, 16.5 cm total length

WT257000 Needle, acc. to Schuhknecht, sharp, straight, size 165

WT257100 Needle, acc. to Schuhknecht, blunt, straight, size 165

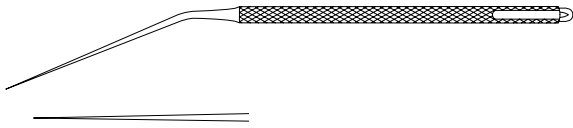

## 90° Schuhknecht Hooks

**Ear hook, acc. to Schuhknecht**  
90° angled, 16.5 cm total length,  
various diameters (mm)

WT258102 Ear hook, acc. to Schuhknecht,  
curved left, angled 90, size 0.2 x 165



WT258104 Ear hook, acc. to Schuhknecht,  
curved left, angled 90, size 0.4 x 165

WT258106 Ear hook, acc. to Schuhknecht,  
curved left, angled 90, size 0.6 x 165

WT258108 Ear hook, acc. to Schuhknecht,  
curved left, angled 90, size 0.8 x 165

WT258110 Ear hook, acc. to Schuhknecht,  
curved left, angled 90, size 1.0 x 165

WT258202 Ear hook, acc. to Schuhknecht,  
curved right, angled 90, size 0.2 x 165



WT258204 Ear hook, acc. to Schuhknecht,  
curved right, angled 90, size 0.4 x 165

WT258206 Ear hook, acc. to Schuhknecht,  
curved right, angled 90, size 0.6 x 165

WT258208 Ear hook, acc. to Schuhknecht,  
curved right, angled 90, size 0.8 x 165

WT258210 Ear hook, acc. to Schuhknecht,  
curved right, angled 90, size 1.0 x 165

WT258302 Ear hook, acc. to Schuhknecht,  
curved up, angled 90, size 0.2 x 165



WT258304 Ear hook, acc. to Schuhknecht,  
curved up, angled 90, size 0.4 x 165

WT258306 Ear hook, acc. to Schuhknecht,  
curved up, angled 90, size 0.6 x 165

WT258308 Ear hook, acc. to Schuhknecht,  
curved up, angled 90, size 0.8 x 165

WT258310 Ear hook, acc. to Schuhknecht,  
curved up, angled 90, size 1.0 x 165

WT258402 Ear hook, acc. to Schuhknecht,  
curved down, angled 90, size 0.2 x 165



WT258404 Ear hook, acc. to Schuhknecht,  
curved down, angled 90, size 0.4 x 165

WT258406 Ear hook, acc. to Schuhknecht,  
curved down, angled 90, size 0.6 x 165

WT258408 Ear hook, acc. to Schuhknecht,  
curved down, angled 90, size 0.8 x 165

WT258410 Ear hook, acc. to Schuhknecht,  
curved down, angled 90, size 1.0 x 165

## 45° Schuhknecht Hooks (1)

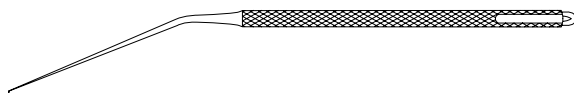

### Ear hook, acc. to Schuhknecht

45° angled, 16.5 cm total length, various diameters (mm)

- |          |  |  |
|----------|--|--|
| WT259002 | Ear hook, acc. to Schuhknecht,<br>curved down, angled 45, size 0.2 x 165 |  |
| WT259004 | Ear hook, acc. to Schuhknecht,<br>curved down, angled 45, size 0.4 x 165 |  |
| WT259006 | Ear hook, acc. to Schuhknecht,<br>curved down, angled 45, size 0.6 x 165 |  |
| WT259008 | Ear hook, acc. to Schuhknecht,<br>curved down, angled 45, size 0.8 x 165 |  |
| WT259010 | Ear hook, acc. to Schuhknecht,<br>curved down, angled 45, size 1.0 x 165 |  |
| WT259102 | Ear hook, acc. to Schuhknecht,<br>curved left, angled 45, size 0.2 x 165 |  |
| WT259104 | Ear hook, acc. to Schuhknecht,<br>curved left, angled 45, size 0.4 x 165 |  |
| WT259106 | Ear hook, acc. to Schuhknecht,<br>curved left, angled 45, size 0.6 x 165 |  |
| WT259108 | Ear hook, acc. to Schuhknecht,<br>curved left, angled 45, size 0.8 x 165 |  |
| WT259110 | Ear hook, acc. to Schuhknecht,<br>curved left, angled 45, size 1.0 x 165 |  |

## 45° Schuhknecht Hooks (2)

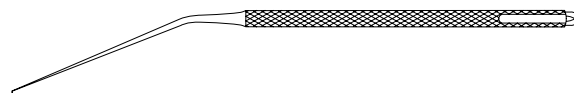

### Ear hook, acc. to Schuhknecht

45° angled, 16.5 cm total length, various diameters (mm)

- |          |   |  |
|----------|---|--|
| WT259202 | Ear hook, acc. to Schuhknecht,<br>curved right, angled 45, size 0.2 x 165 |  |
| WT259204 | Ear hook, acc. to Schuhknecht,<br>curved right, angled 45, size 0.4 x 165 |  |
| WT259206 | Ear hook, acc. to Schuhknecht,<br>curved right, angled 45, size 0.6 x 165 |  |
| WT259208 | Ear hook, acc. to Schuhknecht,<br>curved right, angled 45, size 0.8 x 165 |  |
| WT259210 | Ear hook, acc. to Schuhknecht,<br>curved right, angled 45, size 1.0 x 165 |  |
| WT259302 | Ear hook, acc. to Schuhknecht,<br>curved up, angled 45, size 0.2 x 165    |  |
| WT259304 | Ear hook, acc. to Schuhknecht,<br>curved up, angled 45, size 0.4 x 165    |  |
| WT259306 | Ear hook, acc. to Schuhknecht,<br>curved up, angled 45, size 0.6 x 165    |  |
| WT259308 | Ear hook, acc. to Schuhknecht,<br>curved up, angled 45, size 0.8 x 165    |  |
| WT259310 | Ear hook, acc. to Schuhknecht,<br>curved up, angled 45, size 0.8 x 165    |  |





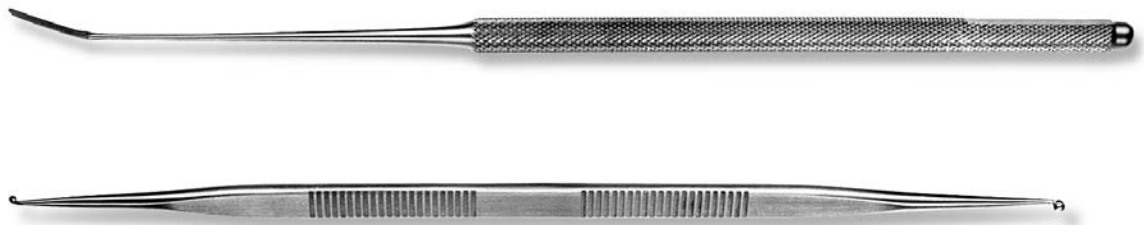





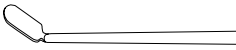



- Micro elevators, raspatories and dissectors:  
delicate and micro models,  
single and double curved models
- Micro Curettes:  
double-ended, sharp models,,  
round and oval cup models,  
straight and curved models

## Micro Elevators, Raspatories, Dissectors

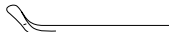
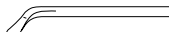
		
	<b>Raspatory</b> micro, 16.5 cm total length	
WT250500	Raspatory, micro, size 165	
	<b>Elevator, acc. to Rosen</b> 1.2 mm width, 16 cm total length	
WT260000	Elevator, acc. to Rosen, size 1.2 x 160	
	<b>Raspatory</b> oval, 1.8 mm width, 16 cm total length	
WT260400	Raspatory, oval, size 1.8 x 160	
	<b>Dissector</b> delicate, 1.4 mm width, 16 cm total length	
WT260500	Dissector, delicate, double curved, right, size 1.4 x 160	
WT260600	Dissector, delicate, double curved, left, size 1.4 x 160	
	<b>Dissector</b> 1.9 mm width, 16 cm total length	
WT260700	Dissector, double curved, right, large, size 1.9 x 160	
WT260800	Dissector, double curved, left, large, size 1.9 x 160	
	<b>Dissector</b> Fisch-type, 1.9 mm width, 16 cm total length	
WT263001	Dissector, double curved, right, size 1.9 x 160	
WT263002	Dissector, double curved, left, size 1.9 x 160	
WT263003	Dissector, acc. to Fisch, single curved, right, size 1.9 x 160	
WT263004	Dissector, acc. to Fisch, single curved, left, size 1.9 x 160	

## House Micro Curettes

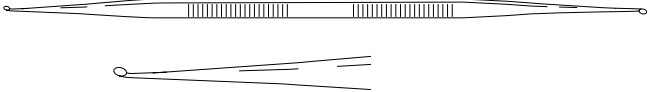
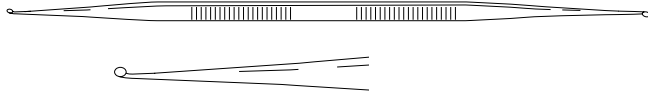
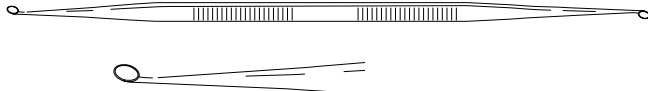

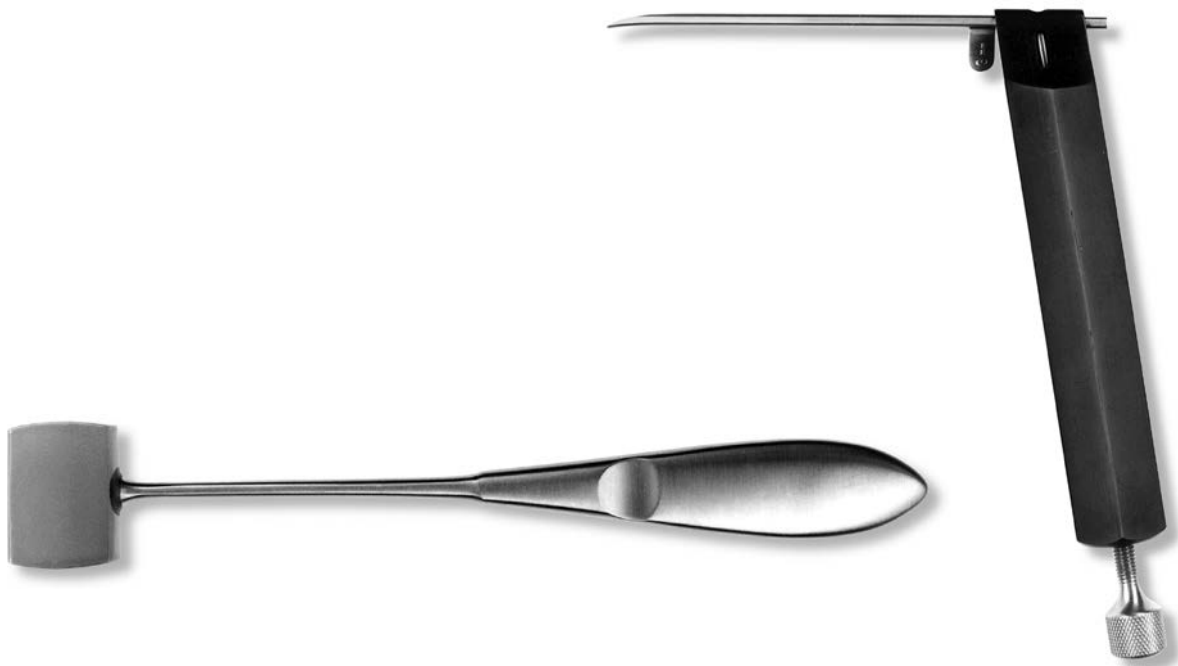
	<b>Curette, acc. to House</b> 17 cm, double-ended, round cups, sharp, curved, 1.0 x 1.2 mm diameter	
WT272500	Curette, acc. to House, round, curved, size 1.0/1.2 x 170	
	<b>Curette, acc. to House</b> 17 cm, double-ended, round cups, sharp, straight, 1.0 x 1.2 mm diameter	
WT272700	Curette, acc. to House, round, straight, size 1.0/1.2 x 170	
	<b>Curette, acc. to House</b> 17 cm, double-ended, oval cups, sharp, curved, various diameters (mm)	
WT272600	Curette, acc. to House, double-ended, oval, curved, size 0.8 x 1.0/1.0 x 1.2 170	
WT272601	Curette, acc. to House, double-ended, oval, curved, size 1.1 x 1.5/1.3 x 1.8 170	
WT272602	Curette, acc. to House, double-ended, oval, curved, size 1.5 x 2.2/1.9 x 2.6 170	
WT272603	Curette, acc. to House, double-ended, oval, curved, size 2.3 x 3.1/2.5 x 3.3 170	



- Special otology mallets
- Micro gouges and mobilization hooks
- Long and finest grasping forceps
- Delicate attic inspection mirror

**Gouge, acc. to Heermann**

curved,  
for partial resection of the bony posterior  
aural meatus and the lateral attic wall,  
11 cm total length, various diameters (mm)

- WT264010 Gouge, acc. to Heermann,  
curved, size 1.0 x 110 
- WT264015 Gouge, acc. to Heermann,  
curved, size 1.5 x 110 
- WT264030 Gouge, acc. to Heermann,  
curved, size 3.0 x 110 

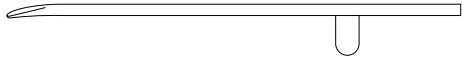

**Handle, acc. to Heermann**

black, 12 cm total length,  
for WT264010–030, WT264301–304

- WT264100 Handle, acc. to Heermann, black,  
for Heermann gouges/micro larynx instruments



**Ear forceps, acc. to Heermann**

long, delicate jaws, 9 cm total length,  
for work between the stapes, in the small cavity  
of the oval window and around the footplate

- WT281700 Ear forceps, acc. to Heermann, straight, size 8

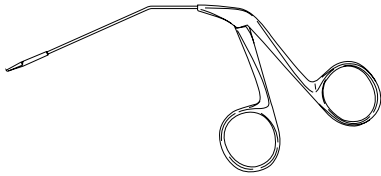

**Mallet, acc. to Heermann**

various total lengths (mm)

- WT263500 Mallet, acc. to Heermann, large, size 220
- WT263501 Mallet, acc. to Heermann, small, size 170

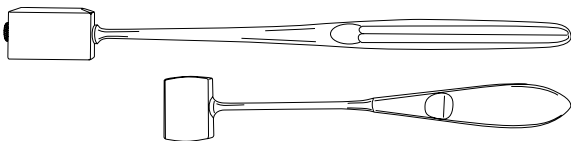

## Micro Gauge, Micro Measuring Device

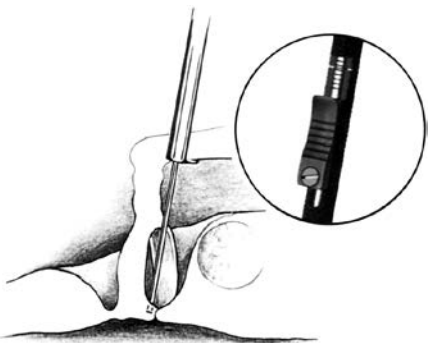
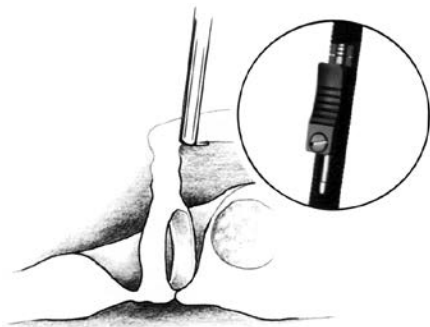

- Microsurgical gauge for stapedectomy and tympanoplasty
- Highly precise scales
- Straight and bajonet curved models
- Introducer for prosthesis

## Measuring Devices

### Gauge pin

18.5 cm total length, 0.4 mm gauge diameter,  
for stapedectomy and tympanoplasty,  
range 0–7 mm,  
handle ebony finished, light in weight

WT269800 Gauge pin, 0-7, black handle, size 0.4 x 185

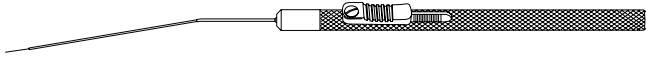

### Gauge pin

21 cm total length, 0.3 mm diameter,  
for stapedectomy and tympanoplasty,  
range 0–10 mm,  
highly precise scale

WT269900 Gauge pin, Explorent type, 0-10, size 0.3 x 210

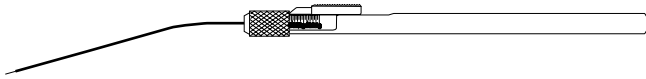

## Measuring Rods



### Gauge pin

3.5 mm, 4.0 mm, 4.5 mm,  
16 cm total length

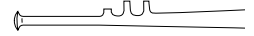

WT256500 Gauge pin, for stapes, size 3.5 x 4.0 x 4.5 160

### Gauge pin, acc. to Fisch

16.5 cm total length,  
various diameter (mm)

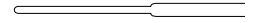

WT263204 Gauge pin, acc. to Fisch, size 0.4 x 165

WT263206 Gauge pin, acc. to Fisch, size 0.6 x 165

WT263208 Gauge pin, acc. to Fisch, size 0.8 x 165

## Introducer

### Introducer, acc. to Plester

16.5 cm total length

WT256800 Introducer, acc. to Plester,  
for stapes prosthesis, size 165

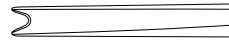

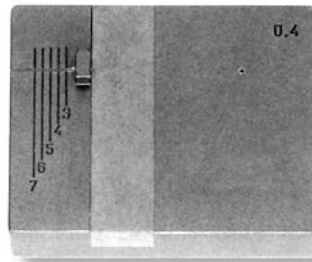
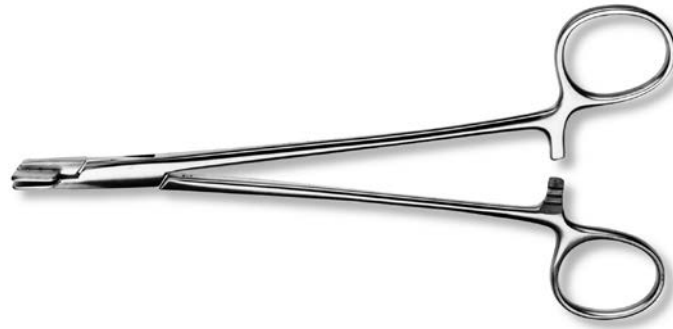

- Gelfoam Pressure Forceps: models with different sizes
- Jigs, blocks and trays for cutting and preparation
- Wire cutter with serrated blades

## Gelfoam Pressure Forceps

### Gelfoam pressure forceps, acc. to House various sizes (mm)

- WT264500 Gelfoam pressure forceps,  
acc. to House, size 11 x 14
- WT264501 Gelfoam pressure forceps,  
acc. to House, size 30 x 30
- WT264502 Gelfoam pressure forceps,  
acc. to House, size 22 x 30  
(not shown)

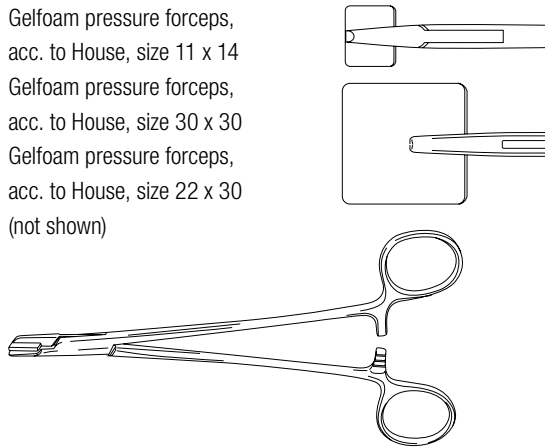

## Scalpel Handles

### Scalpel handle various total lengths (mm)

- WT429003 Scalpel handle, no. 3, solid, size 125
- WT429004 Scalpel handle, no. 4, solid, size 125
- WT429007 Scalpel handle, no. 7, solid, long, size 165
- WT429103 Scalpel handle, no. 3L, solid, straight, size 215
- WT429104 Scalpel handle, no. 4L, solid, straight, size 215
- WT429107 Scalpel handle, no. 7, solid, size 125



## Cutting Tools for Prostheses (cont.)

- WT269300 Cutting jig, for PTFE prostheses

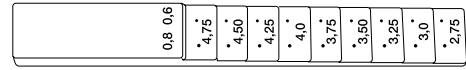

- WT269500 Wire cutting scissors, acc. to Schuhknecht,  
serrated, size 100

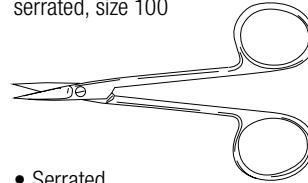

- Serrated

- WT269410 Cutting jig, acc. to Fisch,  
for stapes prostheses, size 0.4 / 0.6

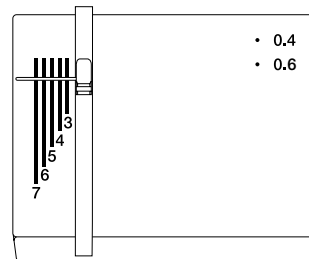

- 0.4 mm Ø and 0.6 mm Ø

- WT269600 Cutting block, acrylic glass, size 80

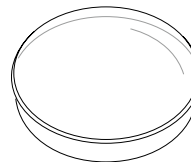

- round, 8 cm Ø,
- autoclavable

- WT269700 Tray, metal, with scale, size 95 x 55

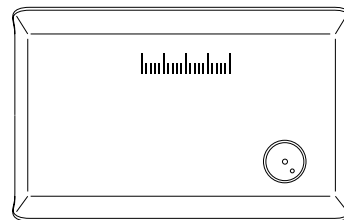

- 95 x 55 mm, for implants





- Models with straight and different curved jaws

## Wire Crimpers

### Ear forceps, acc. to McGee

0.8 x 3.5 mm,  
8 cm working length

WT285000 Ear forceps, acc. to McGee,  
wire closure, curved down, size 8

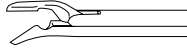

WT285001 Ear forceps, acc. to McGee,  
wire closure, curved left, size 8

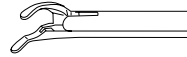

WT285002 Ear forceps, acc. to McGee,  
wire closure, curved right, size 8

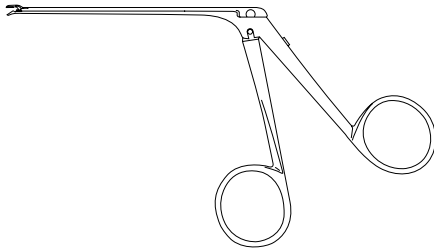
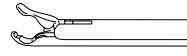

### Ear forceps, acc. to Greven

8 cm working length

WT285010 Ear forceps, acc. to Greven, wire closure, size 8

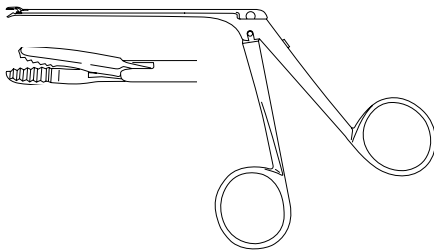

### Ear forceps, acc. to Fisch-McGee

Fisch-type,  
8 cm working length

WT285100 Ear forceps, acc. to Fisch-McGee, wire closure, size 8

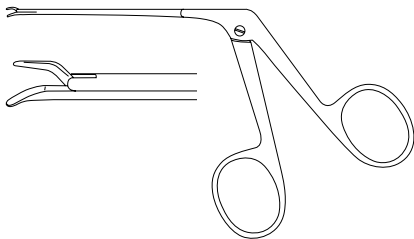



- Very delicate, straight and different curved models
- Crurotomy models left and right curved
- Up- and downbiting Malleus nippers
- Neurectomy scissors with round handle

## Bellucci and Shea-Bellucci Ear Scissors

### Ear scissors, acc. to Bellucci

delicate,  
8 cm working length,  
various blade sizes (mm)

- WT278000 Ear scissors, acc. to Bellucci,  
micro, straight, size 80
- WT278001 Ear scissors, acc. to Bellucci,  
micro, curved to left, size 80
- WT278002 Ear scissors, acc. to Bellucci,  
micro, curved to right, size 80
- WT278003 Ear scissors, acc. to Bellucci,  
micro, curved up, size 80
- WT278100 Ear scissors, acc. to Bellucci,  
micro, straight, size 3.0 x 80

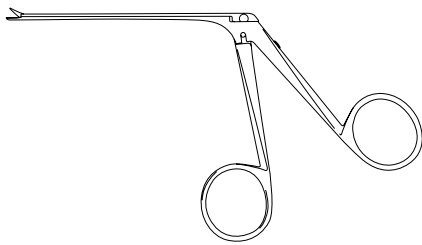
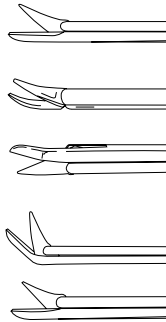

### Ear scissors, acc. to Shea-Bellucci

8 cm working length,  
various blade sizes (mm)

- WT278200 Ear scissors, acc. to Shea-Bellucci,  
straight, size 8.0 x 80
- WT278201 Ear scissors, acc. to Shea-Bellucci,  
curved to left, size 8.0 x 80
- WT278202 Ear scissors, acc. to Shea-Bellucci,  
curved to right, size 8.0 x 80

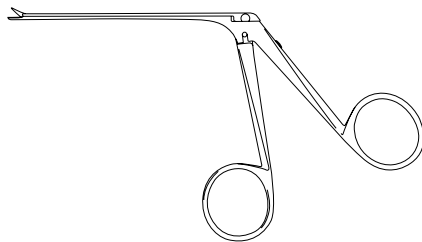
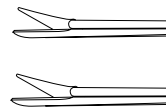

## Fisch Crurotomy Scissors

### Ear scissors

7.5 cm working length,  
Fisch-type

- WT278601 Ear scissors, curved to left, size 80
- WT278602 Ear scissors, curved to right, size 80

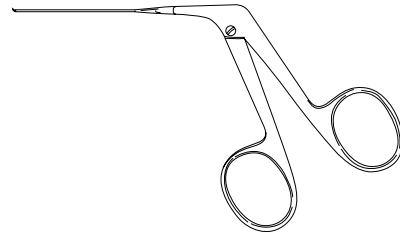
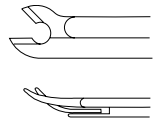

## Dieter Malleus Nipper

### Punch forceps

8 cm working length

- WT283003 Punch forceps, for malleus,  
fine, curved up, size 80
- WT283004 Punch forceps, for malleus,  
fine, curved down, size 80

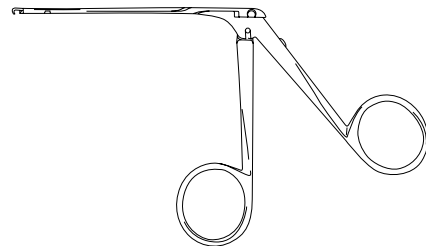
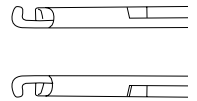

## Accessories

### Protective sleeve

11.5 cm total length,  
for storage and steam sterilization of micro ear forceps

- WT279900 Protective sleeve, PTFE, for ear forceps, size 115



## Fisch Neurectomy Scissors

### Ear scissors, acc. to Fisch

18.5 cm total length, Fisch-type, axial-handle,  
4 mm blade length

- WT278300 Ear scissors, acc. to Fisch, for neurectomy,  
straight, size 4.0 x 185

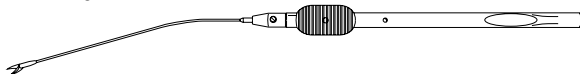



- Oval cupped jaws, straight and curved models
- Models with serrated, sharp and through-cutting jaws

## Hartmann Ear Forceps

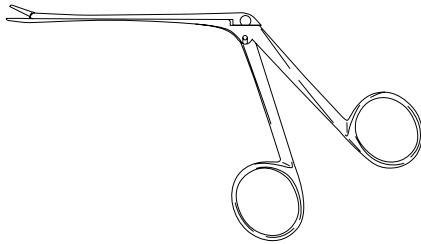

### Ear forceps, acc. to Hartmann

8 cm working length,  
straight, serrated

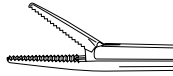

WT126000 Ear forceps, acc. to Hartmann, serrated, size 8

### Ear forceps, acc. to Hartmann

8 cm working length, straight,  
various diameter (mm)

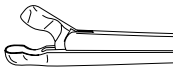

WT127001 Ear forceps, acc. to Hartmann,  
with cupped jaws, size 1.5 x 8

WT127002 Ear forceps, acc. to Hartmann,  
with cupped jaws, size 2.0 x 8.5

WT127003 Ear forceps, acc. to Hartmann,  
with cupped jaws, size 2.5 x 8.5

WT127004 Ear forceps, acc. to Hartmann,  
with cupped jaws, size 3.0 x 8.5

### Ear forceps, acc. to Hartmann-Hoffmann

8 cm working length,  
round cupped jaws,  
through-cutting, 3.0 mm diameter, straight

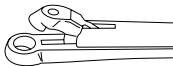

WT127500 Ear forceps, acc. to Hartmann-Hoffmann,  
straight, size 8

## Duckbill Ear Forceps

### Ear forceps

8 cm working length,  
flat jaws, serrated

WT126300 Ear forceps, Duckbill shaped, serrated, size 8

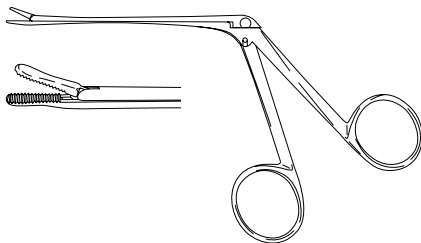

## Struempel Ear Forceps

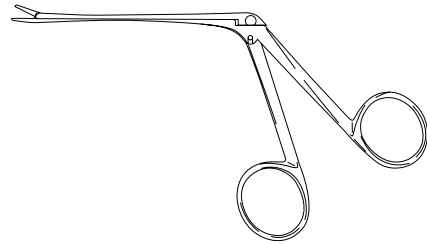

### Ear forceps, acc. to Struempel

various working lengths (cm),  
oval cupped jaws,  
2.5 mm width

WT128000 Ear forceps, acc. to Struempel,  
straight, size 8

WT128001 Ear forceps, acc. to Struempel,  
curved up, size 8

WT128002 Ear forceps, acc. to Struempel,  
curved up, size 8.5

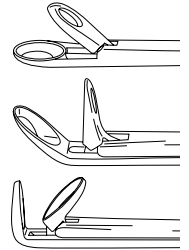

## Wullstein-Blakesley Ear Forceps

### Ear forceps, acc. to Wullstein-Blakesley

tube shaft, 2 mm width,  
10 cm working length, straight

WT129000 Ear forceps, acc. to Wullstein-Blakesley, size 2 x 10





- Models with oval cupped and serrated jaws
- Very delicate and super delicate models
- Slide shaft and tube shaft models

## Micro Ear Forceps With Oval Cups

### Ear forceps

oval cupped jaws, 1.0 x 1.5 mm,  
jaws 4 mm, 8.5 cm working length

- WT279500 Ear forceps, with oval cups, delicate,  
straight, size 1.0 x 8.5
- WT279501 Ear forceps, with oval cups, delicate,  
curved left, size 1.0 x 8.5
- WT279502 Ear forceps, with oval cups, delicate,  
curved right, size 1.0 x 8.5
- WT279503 Ear forceps, with oval cups, delicate,  
curved up, size 1.0 x 8.5
- WT279504 Ear forceps, with oval cups, micro,  
curved down, size 8

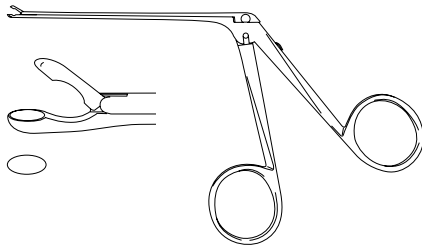

### Ear forceps

oval cupped jaws, 0.7 x 1.0 mm, jaws 3.5 mm,  
8.5 cm working length, straight

- WT279600 Ear forceps, with oval cups, very delicate,  
straight, size 0.7 x 8.5
- WT279700 Ear forceps, with oval cups, super delicate,  
straight, size 0.7 x 8.5

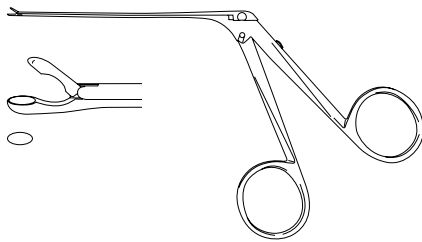

### Ear forceps

9.5 cm working length, tube shaft 1.5 mm diameter,  
oval cupped jaws 2.5 x 5 mm, delicate, straight

- WT279800 Ear forceps, micro, with oval jaws, straight, size 9.5

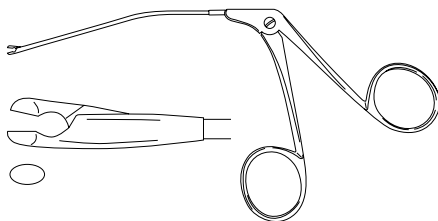

## Serrated Micro Ear Forceps

### Ear forceps

delicate, serrated, 8 cm working length

- WT280000 Ear forceps, micro, serrated, straight, size 8
- WT280500 Ear forceps, micro, serrated, straight, short jaws, size 8
- WT280501 Ear forceps, micro, serrated, curved left, size 8
- WT280502 Ear forceps, micro, serrated, curved right, size 8
- WT280503 Ear forceps, micro, serrated, curved up, size 8

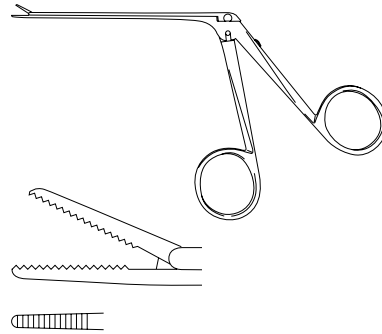

### Ear forceps

Fisch-type, very delicate,  
straight, serrated, 0.7 x 3.5 mm,  
8 cm working length

- WT280600 Ear forceps, micro, serrated, very delicate,  
curved up, size 8

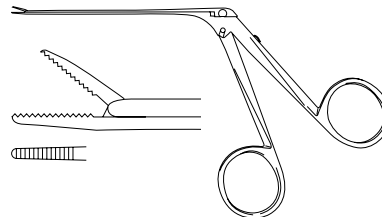

### Ear forceps

super delicate,  
straight, serrated, 0.7 x 3.5 mm,  
8 cm working length

- WT280700 Ear forceps, micro, serrated, super delicate,  
straight, size 8

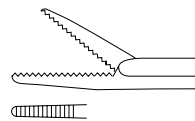



## Delicate Micro Ear Forceps

### Ear forceps, acc. to House

very delicate,  
serrated, tube shaft 0.9 mm diameter,  
8 cm working length, straight

WT281500 Ear forceps, acc. to House, serrated,  
very delicate, size 8

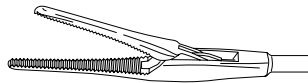
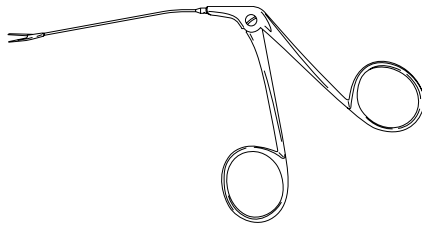

### Ear forceps, acc. to Heermann

long, delicate jaws, 8 cm working length,  
for work between the stapes, in the small cavity  
of the oval window and around the footplate

WT281700 Ear forceps, acc. to Heermann, straight, size 8

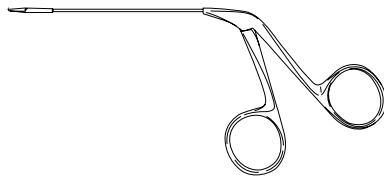

## Accessories

### Protection sleeve

11.5 cm total length,  
for storage and steam sterilization of micro ear forceps

WT279900 Protective sleeve, PTFE, for ear forceps, size 115

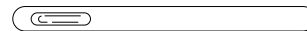





- Models with ring handles, round handles
- Ebony finished models
- T-tube inserter with 3-steps adjustment

## Tube Inserters

### Ear forceps

15.5 cm working length,  
with stylet 1.0 mm (WT285210) and  
1.2 mm diameter (WT285212)

WT285200 Ear forceps, inserter for ventilation tubes,  
size 1.0 and 1.2 x 155

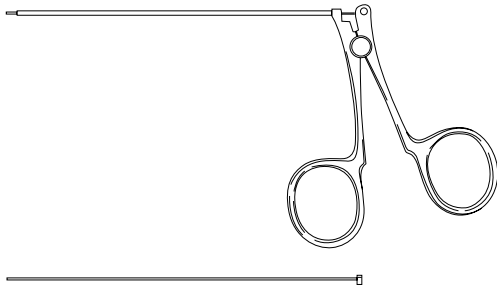

### Mandrin

11.5 cm total length, for WT285200,  
various diameters (mm)

WT285210 Mandrin, for WT285200, size 1.0

WT285212 Mandrin, for WT285200, size 1.2



### Ear forceps, acc. to Morgan

17 cm, conical tip

WT285250 Ear forceps, acc. to Morgan,  
inserter for ventilation tubes, size 170

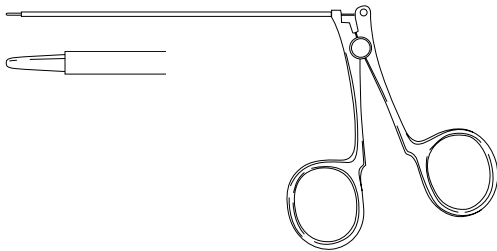

### Ear forceps

14 cm,  
for tubes with 0.95 mm Ø or larger

WT285300 Ear forceps, inserter for ventilation tubes, size 140

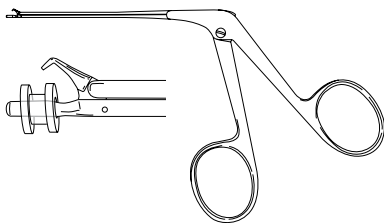

## T-Tube Inserters

### Inserter

handle ebony finished,  
18.5 cm working length

WT285600 Inserter, for T-Tubes, size 185

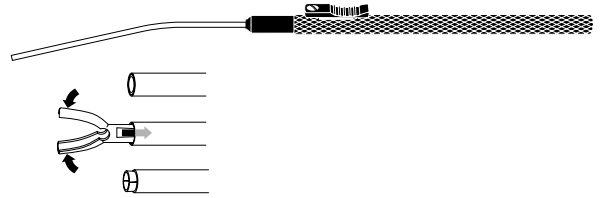

### Inserter

handle ebony finished, 16 cm total length,  
adjustment to the required setting  
(3 steps), allows for the precise  
insertion of 6, 9 and 12 mm T-tubes

WT285700 Inserter, for T-Tubes, size 160

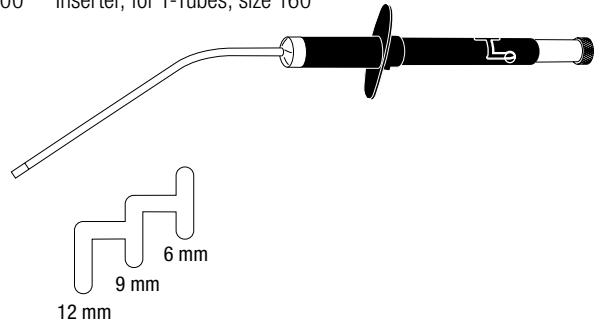

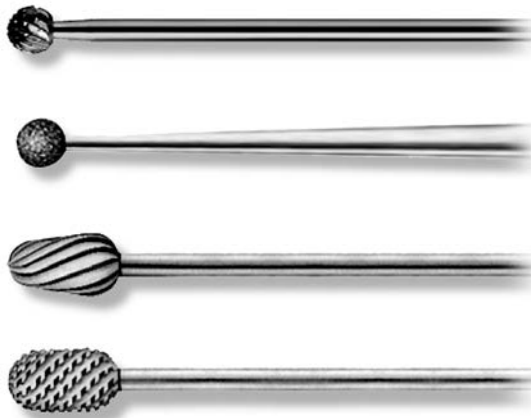

- Round, bud, cylindrical and conical models
- Steel, tungsten carbide and diamond coated models
- Shaft diameter 2.35 mm, for power drills up to 40,000 min<sup>-1</sup>.
- Racks for straight shaft burrs with total length of 70 mm

## Round Standard Burrs

### Burr

round,  
straight shaft, stainless steel,  
2.35 mm shaft Ø,  
70 mm total length ,  
various diameter (mm)

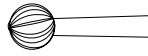

WT236006	Burr, round, size 0.6 x 70
WT236008	Burr, round, size 0.8 x 70
WT236010	Burr, round, size 1.0 x 70
WT236014	Burr, round, size 1.4 x 70
WT236018	Burr, round, size 1.8 x 70
WT236023	Burr, round, size 2.3 x 70
WT236027	Burr, round, size 2.7 x 70
WT236031	Burr, round, size 3.1 x 70
WT236035	Burr, round, size 3.5 x 70
WT236040	Burr, round, size 4.0 x 70
WT236045	Burr, round, size 4.5 x 70
WT236050	Burr, round, size 5.0 x 70
WT236060	Burr, round, size 6.0 x 70
WT236070	Burr, round, size 7.0 x 70

### Burr

round, coarse,  
straight shaft, stainless steel,  
2.35 mm shaft Ø ,  
57 mm total length,  
various diameter (mm)

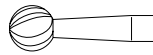

WT000867	Burr, round, size 4.0 x 57
WT000868	Burr, round, size 4.5 x 57
WT000869	Burr, round, size 5.0 x 57
WT000870	Burr, round, size 6.0 x 57
WT000871	Burr, round, size 7.0 x 57

## Round Tungsten Carbide Burrs

### Burr

round,  
cutting edge running over the top,  
straight shaft, stainless steel,  
2.35 mm shaft Ø,  
70 mm total length,  
various diameter (mm)

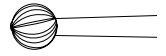

WT236110	Burr, round, tungsten carbide, size 1.0 x 70
WT236118	Burr, round, tungsten carbide, size 1.8 x 70
WT236123	Burr, round, tungsten carbide, size 2.3 x 70
WT236127	Burr, round, tungsten carbide, size 2.7 x 70
WT236131	Burr, round, tungsten carbide, size 3.1 x 70
WT236135	Burr, round, tungsten carbide, size 3.5 x 70
WT236140	Burr, round, tungsten carbide, size 4.0 x 70
WT236145	Burr, round, tungsten carbide, size 4.5 x 70
WT236150	Burr, round, tungsten carbide, size 5.0 x 70
WT236160	Burr, round, tungsten carbide, size 6.0 x 70
WT236170	Burr, round, tungsten carbide, size 7.0 x 70

## Round Diamond Burrs

### Burr

diamond, round,  
straight shaft, stainless steel,  
2.35 mm shaft Ø,  
70 mm total length,  
various diameter (mm)



WT242006	Burr, diamond, size 0.6 x 70
WT242007	Burr, diamond, size 0.7 x 70
WT242008	Burr, diamond, size 0.8 x 70
WT242010	Burr, diamond, size 1.0 x 70
WT242014	Burr, diamond, size 1.4 x 70
WT242018	Burr, diamond, size 1.8 x 70
WT242023	Burr, diamond, size 2.3 x 70
WT242027	Burr, diamond, size 2.7 x 70
WT242031	Burr, diamond, size 3.1 x 70
WT242035	Burr, diamond, size 3.5 x 70
WT242040	Burr, diamond, size 4.0 x 70
WT242045	Burr, diamond, size 4.5 x 70
WT242050	Burr, diamond, size 5.0 x 70
WT242060	Burr, diamond, size 6.0 x 70
WT242070	Burr, diamond, size 7.0 x 70

## Accessories

### Rack

for 70 mm straight shaft burrs,  
holds total of 34 burrs

WT225300 Rack, for 34 burrs

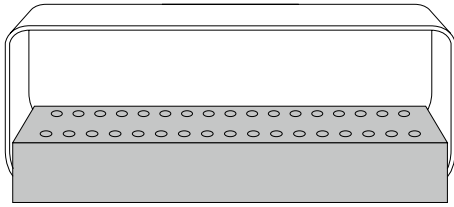

### Wire brush

for burrs, autoclavable,  
5 pcs.

WT226300 Wire brush, 5 pcs.

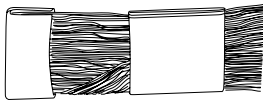

## Dermabraders

### Dermabrader

cylindrical,  
diamond coated,  
straight shaft,  
2.35 mm shaft  $\emptyset$ ,  
50 mm total length,  
12.0 x 15.0 mm working part  $\emptyset$

WT246600 Dermabrader, diamond, size 12/15 x 50

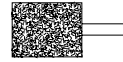





## Drills



Buckingham footplate hand drill,  
 round, knurled handle,  
 straight shaft,  
 sharp tip,  
 149 mm overall length,  
 ebony finish,  
 large  
 medium  
 small

130470  
 130471  
 130472

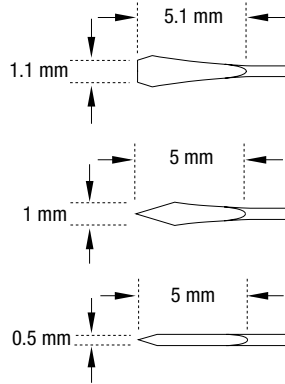

130462

Larkin hand perforator,  
 round, knurled handle,  
 straight shaft,  
 sharp tip,  
 168 mm overall length,  
 ebony finish

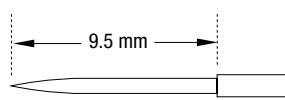

## OtoView Instruments

70235620 OtoView elevator,  
 double-ended,  
 stainless steel,  
 ebony finish



70235621 OtoView knife,  
 double-ended,  
 round,  
 stainless steel,  
 ebony finish



70235622 OtoView knife,  
 sickle,  
 stainless steel,  
 ebony finish



70235623 OtoView knife,  
 triangle,  
 stainless steel,  
 ebony finish



## Instrument Wipes

Micro-Instrument wipes,  
polyurethane ester foam,  
3.5" x 3.5" nonfibrous sponge,  
48 pcs.,  
230030 sterile  
70230034 non-sterile

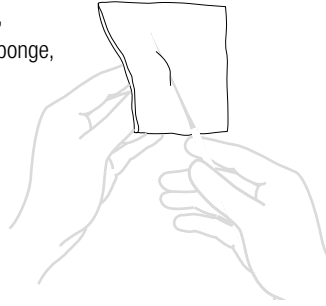

## Myringotomy Kits

Set-Op myringotomy kit,  
sterile, single-use,  
890205 for children (3, 4, and 5 mm specula)  
890206 for adults (4, 5 and 6 mm specula)

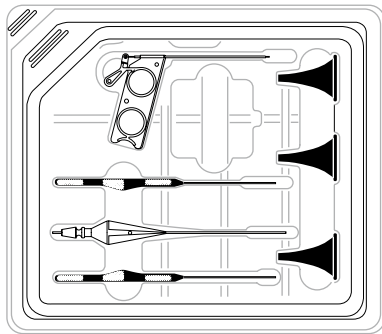

Delivery includes:  
1 Billeau wax curette, 1 16 gauge suction needle with bypass,  
1 myringotomy knife, sickle blade, contoured handle, 1  
ventilation tube inserter (for 1.14 mm inner diameter tubes),  
3 specula

## Head Supports

Shea foam head support,  
nonsterile,  
150179 for children  
150180 for adults

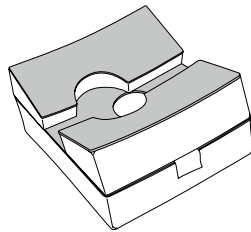

Designed for John J. Shea, M.D.,  
Memphis, TN, USA  
U.S. Patent No. 3,694,831.

## Footplate Hook

Lippy footplate hook,  
round, knurled handle,  
shaft angled 20°,  
170 mm overall length,  
ebony finish,  
130135 angled up 90°, anterior  
130136 angled up 90°, posterior  
130137 angled up 90°, anterior, large  
130138 angled up 90°, posterior, large

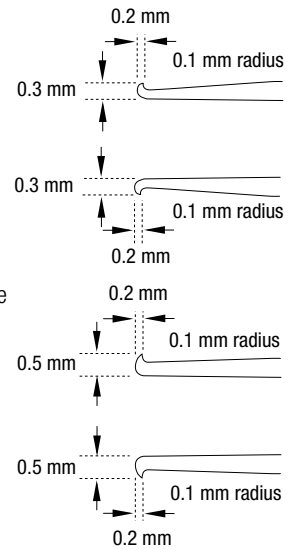

## Depth Gauges

130976 Applebaum measuring rod,  
straight, angled 90°,  
depths markings in 0.5 mm increments,  
round, knurled handle,  
150 mm overall length,  
ebony finish

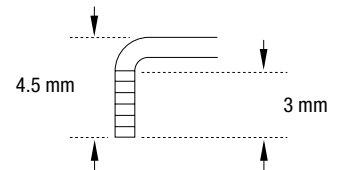

130290 Richards piston depth gauge,  
straight,  
depths markings staggered  
around shaft  
at 3.5 mm, 4.0 mm, 4.5 mm,  
round, knurled handle,  
174 mm overall length,  
ebony finish

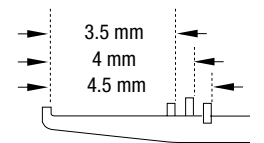

## Depth Gauges

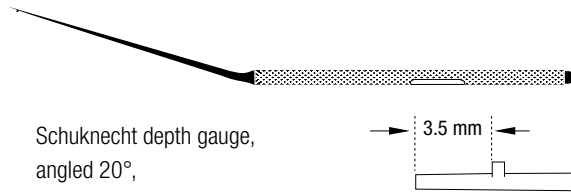

Schuknecht depth gauge,  
angled 20°,  
depth marking at 3.5 mm,  
round, knurled handle,  
154 mm overall length,  
ebony finish

130291 0.6 mm  
130292 0.8 mm

## Buckingham Mirror

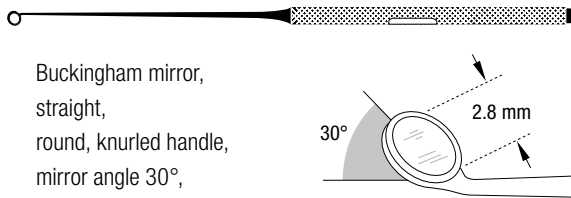

130535 Buckingham mirror,  
straight,  
round, knurled handle,  
mirror angle 30°,  
152 mm overall length,  
vapor blast finish

130536 Protective sleeve,  
for Buckingham mirror 130535,  
white fluoroplastic,  
115 mm overall length



## Cutting Blocks

130130 Austin surgical cutting block,  
black polyoxymethylene,  
63.5 mm diameter

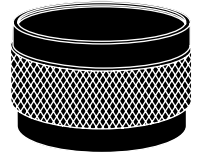

70135800 Goldenberg cutting block,  
stainless steel,  
polyoxymethylene

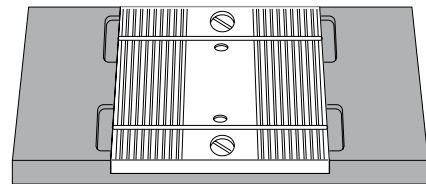

Designed for Robert Goldenberg, M.D., Dayton, OH, USA

130131 House cutting block,  
white polyoxymethylene,  
73 x 38 mm

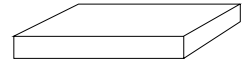

130289 Piston cutting jig,  
stainless steel,  
86 mm overall length

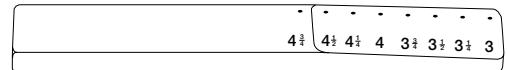

## Vein Press

130146 Vein press,  
15.8 x 15.8 mm press diameter,  
stainless steel,  
114 mm overall length

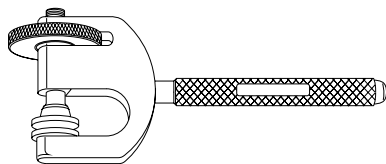



## Antoli-Candela Instruments (1)

130161	Shea knife, round, knurled handle, straight shaft, blade angled 10°, 165 mm overall length	
130162	Right angle knife, round, knurled handle, straight shaft, sharp blade, 165 mm overall length	
130163	Curved knife, round, knurled handle, straight shaft, sharp blade, 165 mm overall length	
130164	Angled elevator blade, round, knurled handle, straight shaft, blade tip angled 15°, 165 mm overall length	
130165	Elevator, small, round, knurled handle, straight shaft, blade tip angled 10°, 165 mm overall length	

## Antoli-Candela Instruments (2)

130166	Elevator, right, round, knurled handle, shaft angled 20°, straight tip, 165 mm overall length	
130167	Footplate mucosa pick, round, knurled handle, straight shaft, blade tip angled 45°, 165 mm overall length	
	Right angle pick, round, knurled handle, straight shaft, blade tip angled 90°, 165 mm overall length, 1 mm	
130168	1 mm	
130169	1.5 mm	
	Obtuse angle pick, 1 mm, round, knurled handle, straight shaft, blade tip angled 45°, 165 mm overall length, 1 mm	
130170	1 mm	
130171	1.5 mm	
	Angled pick, round, knurled handle, shaft angled 10°, blade tip angled down, 165 mm overall length, right	
130172	right	
130173	left	

### Antoli-Candela Instruments (3)

130174 Angled pointed driver,  
round, knurled handle,  
straight shaft,  
blade tip angled 15°, sharp,  
165 mm overall length  
38.1 mm blade length

130175 25.4 mm blade length

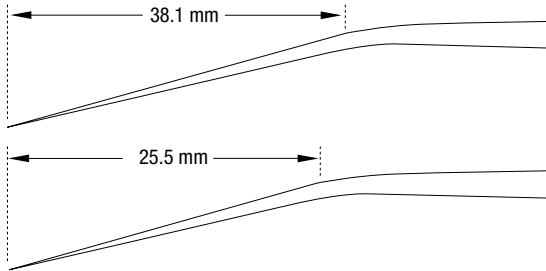

130176 Curved pick,  
round, knurled handle,  
straight shaft,  
curved blade tip,  
165 mm overall length

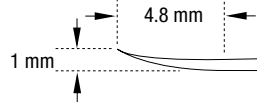

130177 Blunt probe,  
round, knurled handle,  
straight shaft,  
blade tip angled 30°,  
165 mm overall length

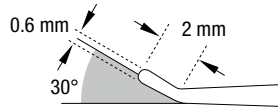

130178 Small window curette,  
flat handle,  
straight shaft,  
165 mm overall length

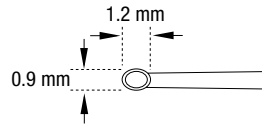

130179 Middle angle curette,  
flat handle,  
shaft angled 10°,  
165 mm overall length

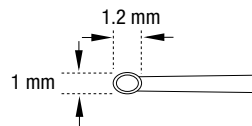

130180 Large curette,  
flat handle,  
shaft angled 10°,  
165 mm overall length

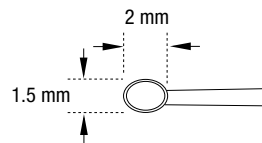

130181 Elevator,  
round, knurled handle,  
straight shaft,  
cup angled up,  
165 mm overall length

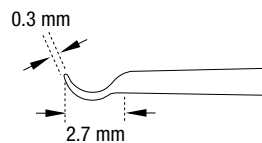

### Antoli-Candela Instruments (4)

130182 Flat curette,  
round, knurled handle,  
straight shaft,  
blade angled up,  
165 mm overall length

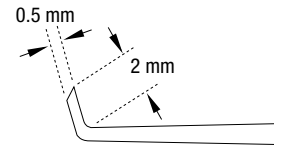

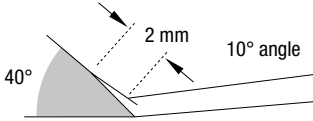
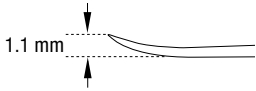
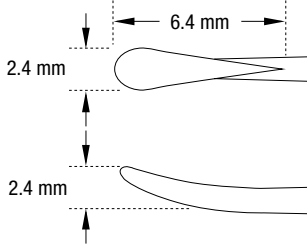
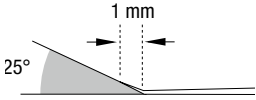
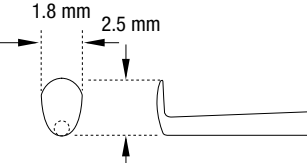
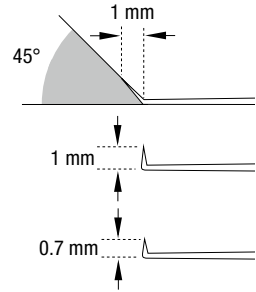
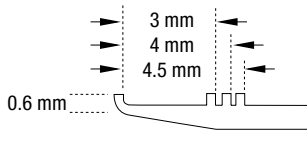
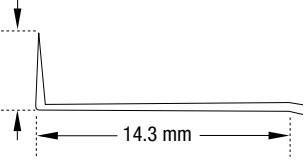
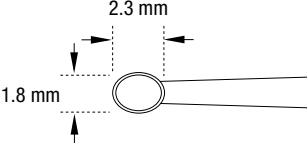
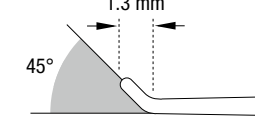
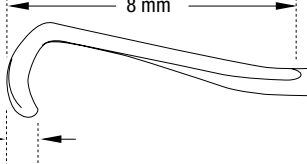
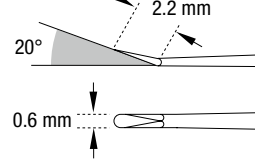
Austin Instruments (1)		Austin Instruments (2)		
130031	Incising knife elevator, round, knurled handle, shaft angled 10°, blade tip angled 40°, 165 mm overall length		130038 Tympanoplasty pick, round, knurled handle, straight shaft, curved tip, 165 mm overall length	
130032	Duckbill knife elevator, round, knurled handle, straight shaft, blunt tip, angled up, 165 mm overall length		Angled pick, round, knurled handle, straight shaft, 165 mm overall length, blade tip angled 25°	
130033	Right angle elevator, round, knurled handle, straight shaft, tip angled up, 165 mm overall length		130039 blade tip angled 25° 130040 blade tip angled 45° 130041 long angled tip 130042 short angled tip	
130034	Measuring rod, round, knurled handle, straight shaft, straight tip, 168 mm overall length		130043 Attic dissector, round, knurled handle, straight shaft, 4.7 mm blade tip angled up, 165 mm overall length	
130035	Curette, flat handle, shaft angled 10°, 152 mm overall length		130044 Probe, round, knurled handle, straight shaft, blade tip angled 45°, 168 mm overall length	
130035	Excavator, round, knurled handle, straight shaft, 165 mm overall length, right tip		130045 Incudostapedial knife, round, knurled handle, straight shaft, blade tip angled 20°, 168 mm overall length	
130036	right tip			
130037-ENT	left tip			

**Austin Instruments (3)**

130046 Chisel,  
round, knurled handle,  
straight shaft,  
straight tip,  
165 mm overall length

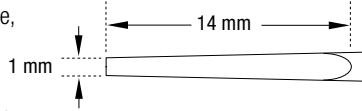

130047 Small sickle knife,  
round, knurled handle,  
straight shaft,  
curved blade,  
165 mm overall length

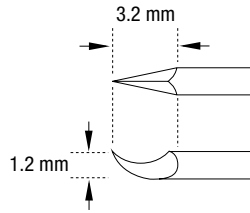

130092 Curette,  
round, knurled handle,  
shaft angled 10°,  
blade tip angled 10°,  
152 mm overall length

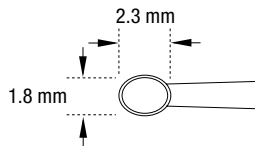

Dissection knife,  
round, knurled handle,  
straight shaft,  
165 mm overall length,  
blade tip angled 45°  
130093 blade tip angled 45°  
130094 blade tip angled 90°

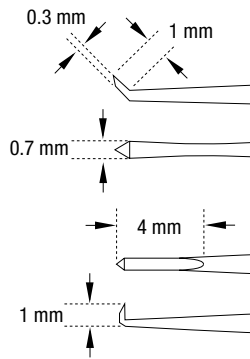

Angled pick,  
round, knurled handle,  
straight shaft,  
blade tip angled,  
165 mm overall length,  
130095 3 mm blade length  
130097 0.3 mm blade length

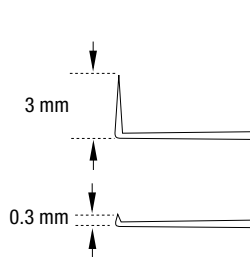

130096 Footplate elevator,  
round, knurled handle,  
shaft angled 10°,  
blade tip angled up,  
165 mm overall length

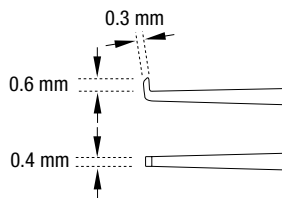

130052 Sterilizing case,  
for 22 instruments  
(not shown)

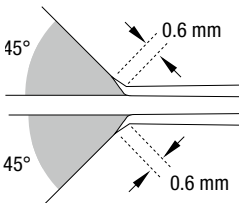
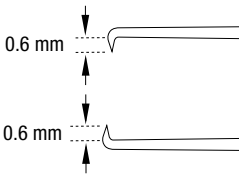
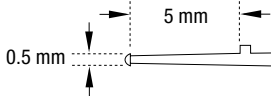
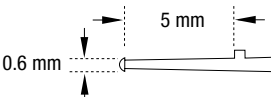
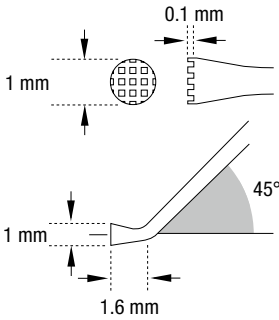
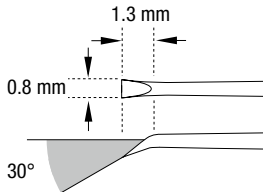

## Farrior Instruments

	<p>Pick, round, knurled handle, shaft angled 30°, ebony finish</p>	
130431	blade tip angled right 45°	
130432	blade tip angled left 45°	
130433	blade tip angled down	
130434	blade tip angled up	
	<p>Rasp, round, knurled handle, shaft angled 30°, straight blade tip, ebony finish</p>	
130435	0.5 mm	
130436	0.6 mm	
	<p>Tamper, round, knurled handle, shaft angled 30°, blade tip angled 45°, ebony finish</p>	
130437		
	<p>Chisel, round, knurled handle, shaft angled 30°, straight blade tip, ebony finish</p>	
130438		

**Goldman Instruments (1)**

130401 Knife,  
round, knurled handle,  
straight shaft,  
blade tip angled 45°,  
ebony finish

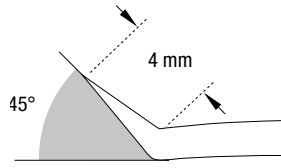

130402 Separator,  
round, knurled handle,  
straight shaft,  
blunt tip,  
ebony finish

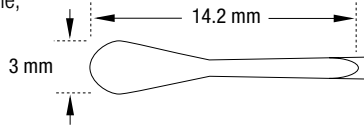

130403 Curved pick,  
round, knurled handle,  
straight shaft,  
curved tip,  
ebony finish,  
dull, 38.1 mm tip radius

130404 dull, 22.1 mm tip radius

130405 sharp, 38 mm tip radius

130406 sharp, 22 mm tip radius

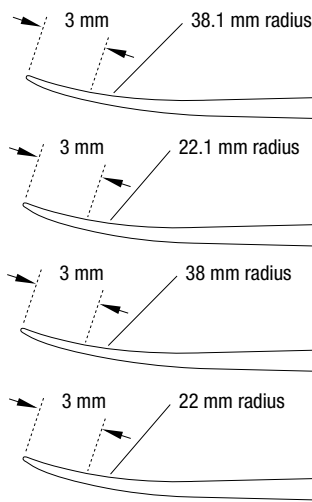

130407 Curette,  
round, knurled handle,  
straight shaft,  
ebony finish,  
medium

130408 large

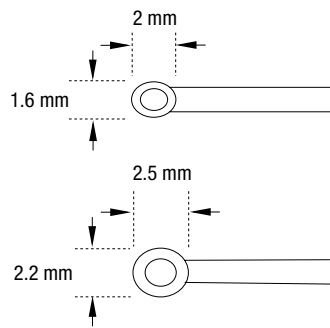

**Goldman Instruments (2)**

130409 Angled pick,  
round, knurled handle,  
straight shaft,  
blade tip angled 90°,  
ebony finish,  
small

130410 large

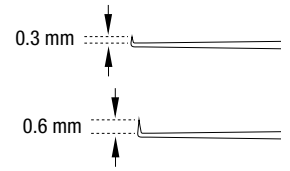

130411 Hoe,  
round, knurled handle,  
straight shaft,  
blade tip angled 45°,  
ebony finish

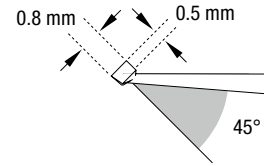

130413 Ball probe,  
round, knurled handle,  
straight shaft,  
ebony finish,  
small, blade tip angled 20°

130414 large, curved tip

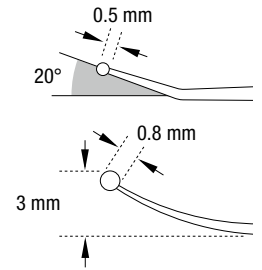

130415 Malleus retractor,  
round, knurled handle,  
straight shaft,  
blade tip angled up and over,  
ebony finish

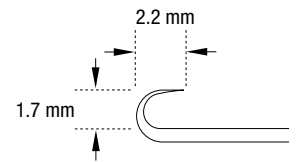

## Guilford Instruments (1)

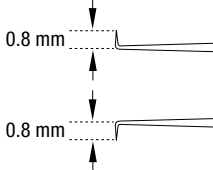
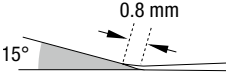
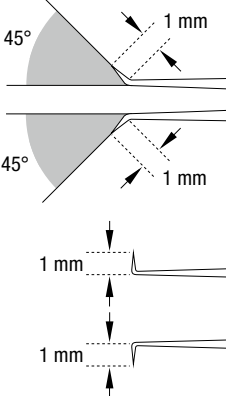
<p>130241 130242</p>	<p>Angled pick, round, knurled handle, shaft angled 6°, 140 mm overall length, ebony finish, blade tip angled left blade tip angled right</p>	
<p>130243</p>	<p>Footplate pick, round, knurled handle, straight shaft, blade tip angled 15°, 140 mm overall length, ebony finish</p>	
<p>130244 130245 130246 130247</p>	<p>Angled pick, round, knurled handle, shaft angled 6°, 140 mm overall length, ebony finish, blade tip angled 45° blade tip angled 45° blade tip angled 90°, right blade tip angled 90°, left</p>	

## Guilford Instruments (2)

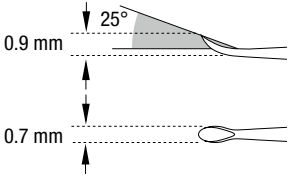
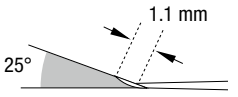
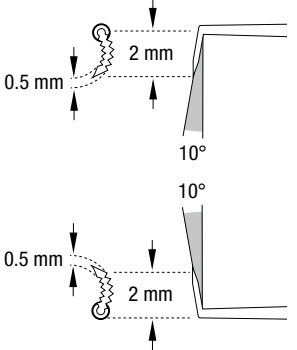
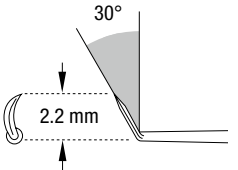
<p>130248</p>	<p>Mucous membrane knife, round, knurled handle, straight shaft, blade tip angled 25°, 140 mm overall length, ebony finish</p>	
<p>130249</p>	<p>Mucous membrane knife, round, knurled handle, straight shaft, blade tip angled 25°, 140 mm overall length, ebony finish</p>	
<p>130250 130251</p>	<p>Crurotomy saw knife, round, knurled handle, straight shaft, 140 mm overall length, ebony finish, blade tip angled 10°, left blade tip angled 10°, right</p>	
<p>130252</p>	<p>Incidostapedial joint knife, round, knurled handle, straight shaft, blade tip angled 30°, 140 mm overall length, ebony finish</p>	

**Guilford Instruments (3)**

Chisel,  
 round, knurled handle,  
 shaft angled 6°,  
 140 mm overall length,  
 ebony finish,  
 straight blade tip  
 130253  
 blade tip angled 8°  
 130254  
 blade tip angled 25°  
 130255

Stapedius tendon knife,  
 round, knurled handle,  
 straight shaft,  
 curved blade,  
 140 mm overall length,  
 ebony finish  
 130256

Stapes knife,  
 round, knurled handle,  
 straight shaft,  
 curved blade,  
 140 mm overall length,  
 ebony finish  
 130257

Angled pick,  
 round, knurled handle,  
 straight shaft,  
 140 mm overall length,  
 ebony finish,  
 blade tip angled 90°,  
 2 mm blade length  
 130258

blade tip angled 45°,  
 2 mm blade length  
 130259

blade tip angled 45°,  
 1 mm blade length  
 130260

Curved mobilization pick,  
 round, knurled handle,  
 straight shaft,  
 curved blade tip,  
 140 mm overall length,  
 ebony finish  
 130261

**Guilford Instruments (4)**

Duckbill elevator,  
 round, knurled handle,  
 straight shaft,  
 blunt blade tip,  
 140 mm overall length  
 ebony finish,  
 small  
 130262  
 large  
 130263

Annulus elevator,  
 round, knurled handle,  
 straight shaft,  
 blade tip angled 15°,  
 140 mm overall length,  
 ebony finish  
 130264

Curette,  
 round, knurled handle,  
 straight shaft,  
 140 mm overall length  
 ebony finish,  
 straight, small  
 130265  
 angled, small  
 130266  
 angled medium  
 130267

Curette,  
 round, knurled handle,  
 goose-neck shaft,  
 140 mm overall length  
 ebony finish,  
 large  
 130268  
 large, cut up  
 130269

Mucous membrane knife,  
 round, knurled handle,  
 straight shaft,  
 straight blade tip,  
 140 mm overall length,  
 ebony finish  
 130270

Hough Instruments (1)		Hough Instruments (2)			
130101	Curette, round, knurled handle, straight shaft, 152 mm overall length, ebony finish, blade tip curved right		130108	Derlacki mobilizer, round, knurled handle, shaft angled 10°, blade tip angled 15°, 165 mm overall length, ebony finish	
130102	blade tip curved left		130109	Big curve pick, round, knurled handle, straight shaft, curved blade tip, 152 mm overall length, ebony finish	
130103	Stapes knife, round, knurled handle, straight shaft, blade tip angled 50°, 152 mm overall length, ebony finish		130110	Gouge, round, knurled handle, straight shaft, curved blade tip, 152 mm overall length, ebony finish	
130104	Annulus elevator, flat handle, bayonet shaft, blunt blade tip, angled up, 165 mm overall length, ebony finish		130111	Chisel, round, knurled handle, shaft angled 10°, straight blade tip, 152 mm overall length, ebony finish	
130105	Spatula, round, knurled handle, straight shaft, blunt blade tip, 152 mm overall length, ebony finish		130112	Gentle curve pick, round, knurled handle, straight shaft, curved blade tip, 152 mm overall length, ebony finish	
130106	Curette, flat handle, straight shaft, 152 mm overall length, ebony finish, small				
130107	large				

### Hough Instruments (3)

<p>130113 130114 130115 130116</p>	<p>Whirleybird, round, knurled handle, straight shaft, 152 mm overall length, ebony finish, large right tip large left tip small right tip small left tip</p>	
<p>130117</p>	<p>Angled pick, round, knurled handle, shaft angled 15°, angled blade tip, 152 mm overall length, ebony finish</p>	
<p>130118</p>	<p>Excavator, round, knurled handle, shaft angled 15°, blade tip angled up, 152 mm overall length, ebony finish</p>	
<p>130119</p>	<p>Angled pick, round, knurled handle, shaft angled 15°, blade tip angled 45°, 152 mm overall length, ebony finish</p>	
<p>130120</p>	<p>Tiny tendon knife, round, knurled handle, straight shaft, straight blade tip, 152 mm overall length, ebony finish</p>	

## Complete House Set

130557 House set

Delivery includes:  
 knives 130561/-62/-69, 230340,  
 separators 130563/-64,  
 needles 130565/-66/-70, elevator 130567, curette 130568,  
 measuring rods 130571/-72/-73, Barbara 130574,  
 hooks 130575/-76/-77/-78, 230336/-37,  
 chisel 130580, wire guide 130581, pick 230331,  
 House Crabtree 550738, dissector Crabtree 230332, stapes  
 230333, narrow 230334, weapons 230336/-37

## Components House Set (1)

130561 Sickle knife, no. 1,  
 round, knurled handle,  
 straight shaft,  
 straight blade tip,  
 vapor blast finish

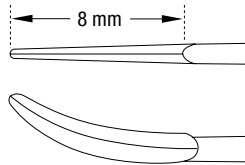

130562 Lancet knife, no. 2,  
 round, knurled handle,  
 straight shaft,  
 blade tip angled 40°,  
 vapor blast finish

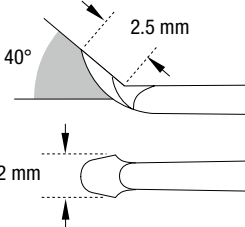

130563 Wide separator,  
 flat handle,  
 bayonet shaft,  
 blunt tip,  
 vapor blast finish

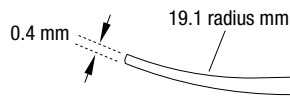

130564 Narrow separator,  
 flat handle,  
 bayonet shaft,  
 blunt tip,  
 vapor blast finish

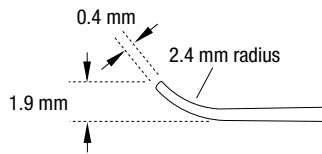

## Components House Set (2)

Rosen needle,  
 round, knurled handle,  
 straight shaft,  
 vapor blast finish

130565 blunt tip

130566 sharp tip

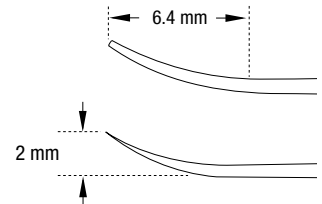

130567 Stapes elevator,  
 round, knurled handle,  
 straight shaft,  
 blade tip angled 15°,  
 vapor blast finish

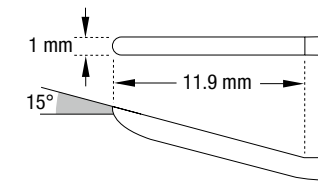

130568 Stapes curette,  
 flat handle,  
 straight shaft,  
 tip cuts up and down,  
 vapor blast finish

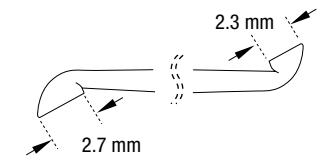

130569 Joint knife,  
 round, knurled handle,  
 straight shaft,  
 blade tip angled 65°,  
 vapor blast finish

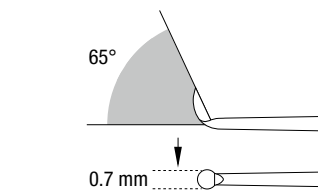

130570 Heavy needle,  
 round, knurled handle,  
 straight shaft,  
 curved blade tip,  
 vapor blast finish

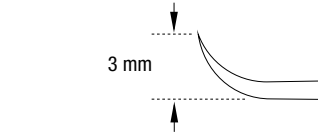

Measuring rod,  
 round, knurled handle,  
 straight shaft,  
 straight tip,  
 vapor blast finish

130571 4 mm

130572 4.5 mm

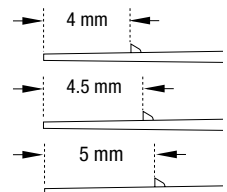

130573 5 mm

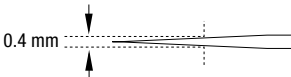
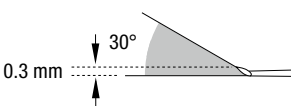
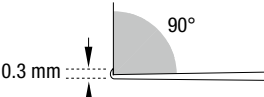
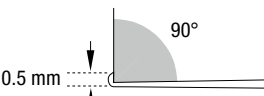
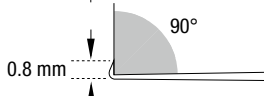
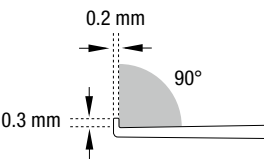
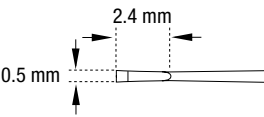
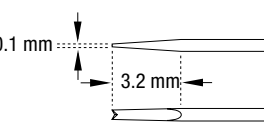
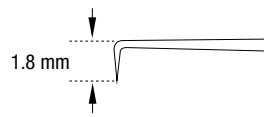

### Components House Set (3)

130574	Barbara, round, knurled handle, straight shaft, straight tip, vapor blast finish	
130575	Obtuse hook, round, knurled handle, shaft angled 30°, straight tip, vapor blast finish	
	Hook, round, knurled handle, straight shaft, blade tip angled 90°, vapor blast finish,	
130576	0.3 mm	
130577	0.5 mm	
130578	0.8 mm	
130579	Excavator, round, knurled handle, straight shaft, blade tip angled 90°, vapor blast finish	
130580	Chisel, round, knurled handle, straight shaft, straight tip, vapor blast finish	
130581	Wire guide, round, knurled handle, straight shaft, straight tip, vapor blast finish	
230331	Strut pick, hexagonal handle, straight shaft, angled blade tip, vapor blast finish	

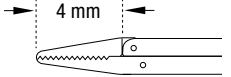
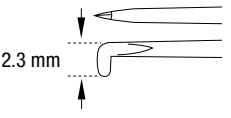
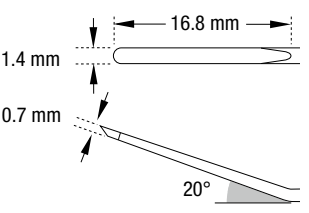
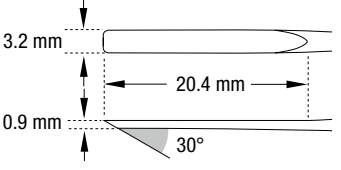
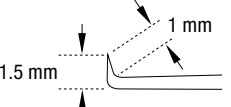
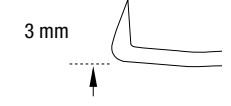
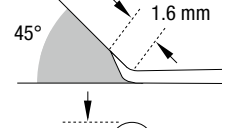
### Components House Set (4)

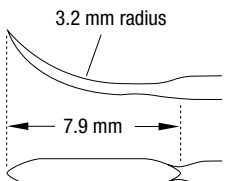
550738	House Crabtree, hexagonal handle, straight shaft, blade tip angled 90°, vapor blast finish	
230332	Dissector Crabtree, hexagonal handle, straight shaft, blade tip angled 90°, vapor blast finish	
230333	Insulated stapes, straight, octagonal handle, angled shaft, vapor blast finish	
230334	Narrow, octagonal handle, straight shaft, blade tip angled 30°, electropolish finish	
	Hook, octagonal handle, straight shaft, angled tip, satin finish	
230336	1.5 mm	
230337	3 mm	
	Sheehy weapon, octagonal handle, straight shaft, angled blade tip, satin finish,	
230338	2 mm	
230339	2.4 mm	
230340	Sheehy flap knife, hexagonal handle, straight shaft, curved blade tip, vapor blast finish	



## Jordan Instruments (1)

130381 Angular knife,  
round, knurled handle,  
straight shaft,  
blade tip angled 45°,  
174 mm overall length,  
ebony finish

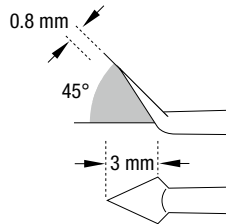

130382 Oval knife,  
round, knurled handle,  
straight shaft,  
blade tip angled 50°,  
174 mm overall length,  
ebony finish

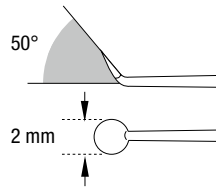

Pick,  
round, knurled handle,  
bayonet shaft,  
straight blade tip,  
165 mm overall length,  
ebony finish,

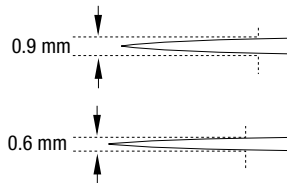

130383 heavy, 0.9 mm  
130384 slim, 0.6 mm

## Jordan Instruments (2)

Angled pick,  
round, knurled handle,  
bayonet shaft,  
angled blade tip,  
165 mm overall length,  
ebony finish,  
130389 tip angled right  
130390 tip angled down  
130391 tip angled left

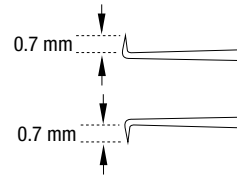

130392 Slim pick,  
round, knurled handle,  
bayonet shaft,  
blade tip angled 45°,  
165 mm overall length,  
ebony finish

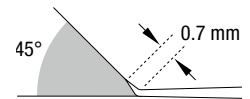

130393 Capsule knife,  
round, knurled handle,  
bayonet shaft,  
blade tip angled 45°,  
165 mm overall length,  
ebony finish

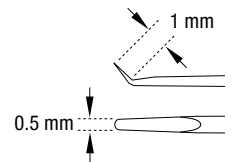

130394 Measuring rod,  
round, knurled handle,  
bayonet shaft,  
straight blade tip,  
166 mm overall length,  
ebony finish

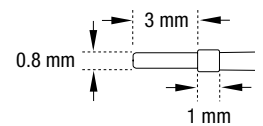

**McGee Instruments (1)**

130441 Footplate hook,  
round, knurled handle,  
shaft angled 20°,  
blade tip angled 90°,  
154 mm overall length,  
ebony finish,  
anterior

130442 posterior

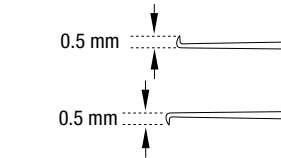

130443 Double bladed knife,  
round, knurled handle,  
shaft angled 20°,  
straight blade tip,  
154 mm overall length,  
ebony finish

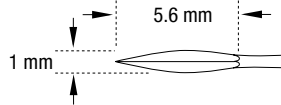

Pick,  
round, knurled handle,  
shaft angled 20°,  
straight blade tip,  
157 mm overall length,  
ebony finish,

130444 0.76 mm

130445 0.5 mm

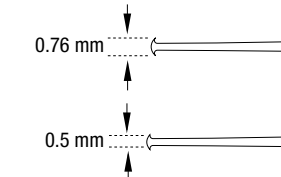

130446 Angled pick,  
round, knurled handle,  
shaft angled 20°,  
blade tip angled 20°,  
157 mm overall length,  
ebony finish

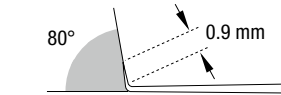

130447 Straight pick,  
round, knurled handle,  
shaft angled 20°,  
straight blade tip,  
154 mm overall length,  
ebony finish

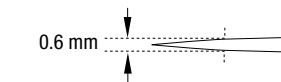

130448 Flat chisel,  
round, knurled handle,  
shaft angled 20°,  
blade tip slightly angled,  
165 mm overall length,  
ebony finish

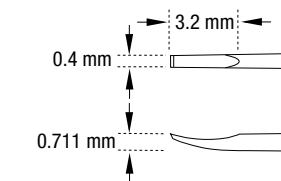

**McGee Instruments (2)**

130449 Elevator,  
flat handle,  
bayonet shaft,  
blunt tip, angled up,  
158 mm overall length,  
ebony finish

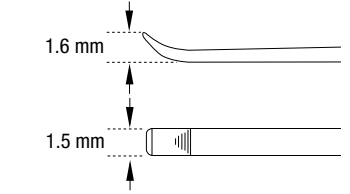

130450 Separator,  
round, knurled handle,  
straight shaft,  
blade tip angled 10°,  
156 mm overall length,  
ebony finish

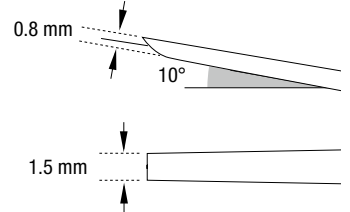

130451 Anterior canal elevator,  
round, knurled handle,  
straight shaft,  
blunt tip, angled up,  
155 mm overall length,  
ebony finish

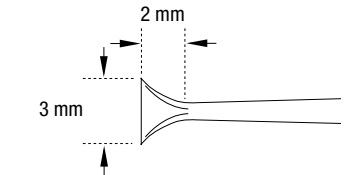

130452 Roller knife, transverse,  
flat handle,  
straight shaft,  
straight blade tip,  
158 mm overall length,  
ebony finish

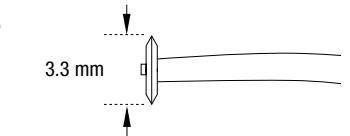

130453 Roller knife, sagittal,  
flat handle,  
straight shaft,  
straight blade tip,  
158 mm overall length,  
ebony finish

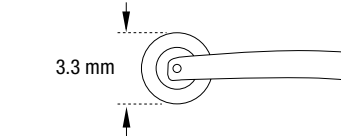

## Ronis Instruments (1)

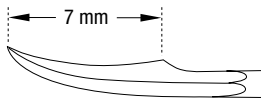
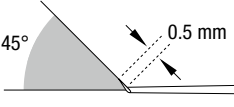
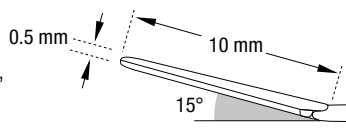
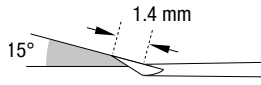
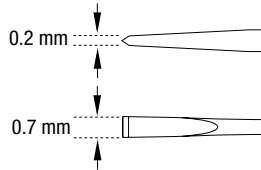
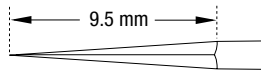
- 130351 Flap knife,  
round, knurled handle,  
straight shaft,  
straight blade tip,  
152 mm overall length,  
ebony finish
- 
- 130352 Periosteal knife,  
round, knurled handle,  
straight shaft,  
blade tip angled 45°,  
152 mm overall length,  
ebony finish
- 
- 130353 Elevator,  
round, knurled handle,  
straight shaft,  
blade tip angled up 15°,  
152 mm overall length,  
ebony finish
- 
- 130354 Joint separator,  
round, knurled handle,  
straight shaft,  
blade tip angled 15°,  
152 mm overall length,  
ebony finish
- 
- 130355 Chisel,  
round, knurled handle,  
straight shaft,  
straight blade tip,  
152 mm overall length,  
ebony finish
- 
- 130356 Perforator,  
round, knurled handle,  
straight shaft,  
straight blade tip,  
152 mm overall length,  
ebony finish
- 

## Ronis Instruments (2)

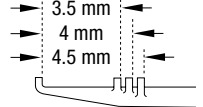
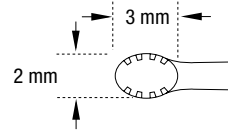
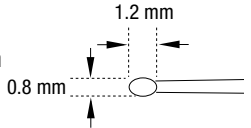
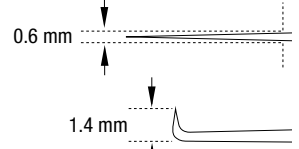
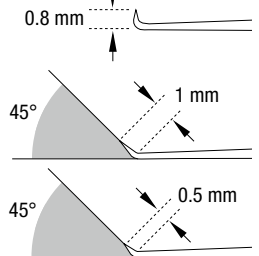
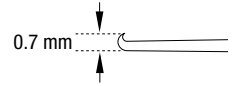
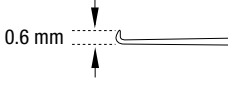
- 130357 Measuring rod,  
round, knurled handle,  
straight shaft,  
152 mm overall length,  
ebony finish
- 
- Curette,  
flat handle,  
152 mm overall length,  
ebony finish,  
shaft angled, tip 2 x 2.8 mm
- 
- 130358 shaft angled, tip 2 x 2.8 mm
- 130359 shaft angled 10°, tip 0.8 x 1.2 mm
- 
- Pick,  
round, knurled handle,  
straight shaft,  
152 mm overall length,  
ebony finish,  
straight blade tip
- 
- 130360 angled blade tip, 1.4 mm
- 130361 angled blade tip, 0.8 mm
- 130362 blade tip angled 45°, 1 mm
- 130363 blade tip angled 45°, 0.5 mm
- 
- 130365 Fine right angle hook,  
round, knurled handle,  
straight shaft,  
90° hook,  
152 mm overall length,  
ebony finish
- 
- 130366 Fine hook,  
round, knurled handle,  
straight shaft,  
angled blade tip,  
152 mm overall length,  
ebony finish
- 

## Scheer Instruments (1)

130302 Knife and elevator, round, knurled handle, straight shaft, blade tip angled 45°, 161 mm overall length, ebony finish

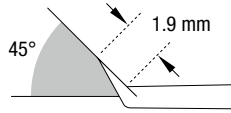

130303 Elevator, round, knurled handle, straight shaft, blunt tip, angled up, 161 mm overall length, ebony finish

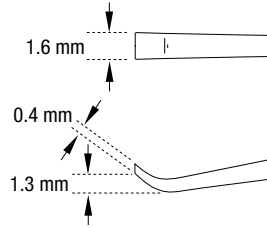

Curette, flat handle, straight shaft, 168 mm overall length, ebony finish,

130304 tip 1.7 x 2.4 mm  
130305 tip 1.8 x 2.5 mm

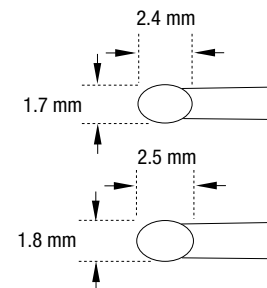

130306 45° angle pick, round, knurled handle, straight shaft, blade tip angled up, 161 mm overall length, ebony finish

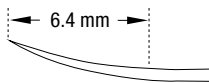

130307 Plastic tube, round, knurled handle, straight shaft, straight blade tip, 161 mm overall length, ebony finish

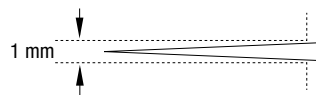

130308 Footplate pick, round, knurled handle, straight shaft, blade tip angled 20°, 161 mm overall length, ebony finish

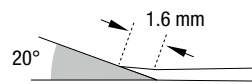

130309 Gelfoam placer, round, knurled handle, straight shaft, curved blade tip, 161 mm overall length, ebony finish

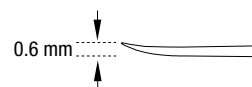

## Scheer Instruments (2)

130310 Fine right-angle pick, round, knurled handle, straight shaft, angled blade tip, 162 mm overall length, ebony finish

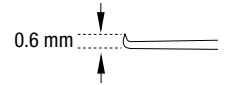

130311 Crura breaker, round, knurled handle, straight shaft, angled blade tip, 162 mm overall length, ebony finish

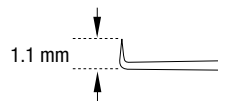

130312 Pick, round, knurled handle, straight shaft, angled blade tip, 162 mm overall length, ebony finish

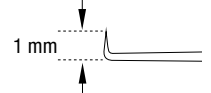

130313 Hook (delicate), round, knurled handle, straight shaft, blade tip curved up, 161 mm overall length, ebony finish

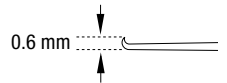

130316 Firm hook, round, knurled handle, straight shaft, blade tip curved up, 161 mm overall length, ebony finish

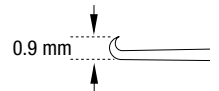

130317 Firm pick, round, knurled handle, straight shaft, angled blade tip, 162 mm overall length, ebony finish

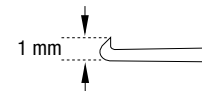

130318 Oval window rasp, round, knurled handle, straight shaft, straight blade tip, 161 mm overall length, ebony finish

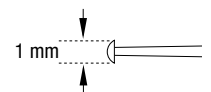



## Complete Schuknecht Set

130225 Complete set

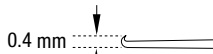
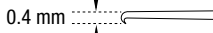
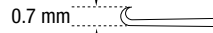
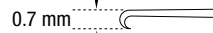
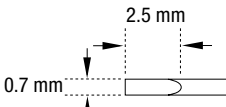
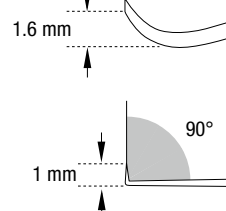

Delivery includes:

Hooks 130201/-02/-03/-04/-06, elevators 130205/-13/-14, pick 130207, spatula 130208, knives 130211/-12

## Components Schuknecht Set (1)

	Hook, round, knurled handle, shaft angled 20°, 154 mm overall length, ebony finish,	
130201	0.4 mm tip, angled up	
130202	0.4 mm tip, angled down	
130203	0.7 mm tip, angled up	
130204	0.7 mm tip, angled down	
130205	Oval window elevator, round, knurled handle, shaft angled 20°, curved blade tip, 154 mm overall length, ebony finish	
130206	Hook, round, knurled handle, shaft angled 20°, tip angled 90°, 154 mm overall length, ebony finish	
130207	Pick, round, knurled handle, shaft angled 20°, straight tip, 154 mm overall length, ebony finish	

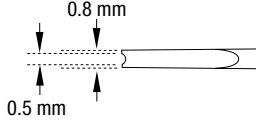
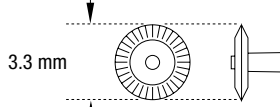
## Components Schuknecht Set (2)

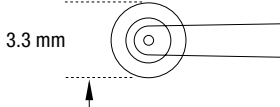
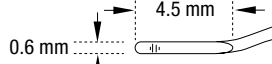
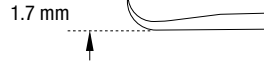
130208	Spatula, round, knurled handle, shaft angled 20°, blunt tip, 154 mm overall length, ebony finish	
	Roller knife, flat handle, shaft angled 20°, 154 mm overall length, ebony finish,	
130211	transverse, straight tip	
130212	sagittal, sharp tip	
	Modified Hough elevator, round, knurled handle, shaft angled 20°, 154 mm overall length, ebony finish,	
130213	left tip	
130214	right tip	

## Shea Instruments (1)

130015 Incising knife,  
round, knurled handle,  
shaft angled 10°,  
blade tip angled 45°,  
174 mm overall length,  
ebony finish

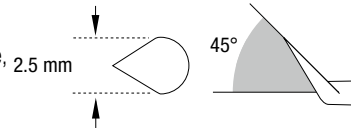

130016-ENT Curette,  
flat handle,  
shaft angled 10°,  
straight tip,  
146 mm overall length,  
ebony finish

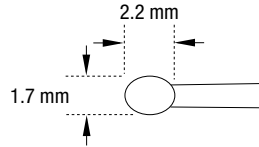

Elevator,  
round, knurled handle,  
straight shaft,  
174 mm overall length,  
ebony finish,

130017 tip angled left 10°  
130018 tip angled right 10°

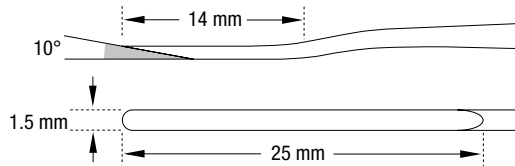

130019 Pick,  
round, knurled handle,  
straight shaft,  
curved tip,  
174 mm overall length,  
ebony finish

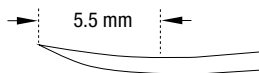

Fenestra hook,  
round, knurled handle,  
straight shaft,  
174 mm overall length,  
ebony finish,

130020 tip angled up 25°  
130021-ENT tip angled up 45°  
130022 tip angled up 90°, 1 mm  
130023 tip angled up 90°, 0.6 mm

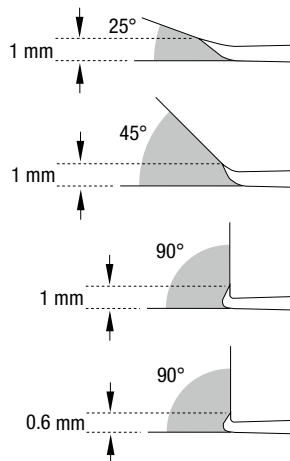

## Shea Instruments (2)

130024 Large angled pick,  
round, knurled handle,  
straight shaft,  
angled tip,  
174 mm overall length,  
ebony finish

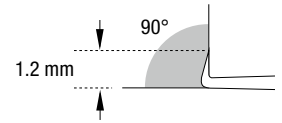

130025-ENT Anterior crurotomy knife,  
round, knurled handle,  
straight shaft,  
blade tip angled 45°,  
174 mm overall length,  
ebony finish

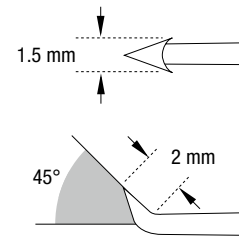

### Shea/Robertson Instruments (1)

130851 Duckbill elevator, round, knurled handle, straight shaft, curved blunt tip, ebony finish

130852 Reverse elevator, round, knurled handle, straight shaft, tip angled 90°, ebony finish

Excavator, round, knurled handle, straight shaft, tip angled 90°, ebony finish

130853 right

130854 left

130855 Attic dissector, round, knurled handle, straight shaft, tip angled 90°, ebony finish

### Shea/Robertson Instruments (2)

Pick, round, knurled handle, straight shaft, ebony finish

130856 sharp, tip angled 45°

130857 blunt, tip angled 45°

130858 sharp, tip angled 90°

130859 Probe, round, knurled handle, straight shaft, tip angled 90°, ebony finish

130860 Middle ear mirror, round, knurled handle, straight shaft, angled mirror tip, 1.3 x 3.2 mm, vapor blast finish

